

SANYO

INSTRUCTION MANUAL

VPC-HD1000EX
VPC-HD1000
VPC-HD1000GX

Digital Movie Camera

Xacti 

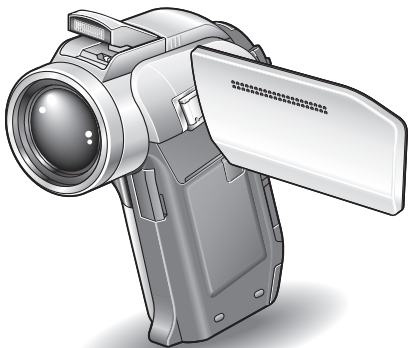

HDMI[™]
HIGH-DEFINITION MULTIMEDIA INTERFACE

Important note

This manual explains how to safely operate the VPC-HD1000EX, VPC-HD1000 and VPC-HD1000GX.

Any information regarding only one of these products will be labeled as such.

Please read these instructions carefully before using the camera.

Make sure to read and understand the separate booklet "SAFETY MANUAL".

Keep this manual in a safe place for later reference.

Warning

TO PREVENT THE RISK OF FIRE OR ELECTRIC SHOCK, DO NOT EXPOSE THIS APPLIANCE TO RAIN OR MOISTURE.

FOR AMERICAN USERS

The following advisory is included in accordance with the laws of the State of California (USA):

WARNING:

This product contains chemicals, including lead, known to the State of California to cause cancer, birth defects or other reproductive harm. **Wash hands after handling.**

- This equipment has been tested and found to comply with the limits for a Class B digital device, pursuant to Part 15 of the FCC Rules. These limits are designed to provide reasonable protection against harmful interference in a residential installation. This equipment generates, uses and can radiate radio frequency energy and, if not installed and used in accordance with the instructions, may cause harmful interference to radio communications. However, there is no guarantee that interference will not occur in a particular installation. If this equipment does cause harmful interference to radio or television reception, which can be determined by turning the equipment off and on, the user is encouraged to try to correct the interference by one or more of the following measures:
 - Reorient or relocate the receiving antenna.
 - Increase the separation between the equipment and receiver.
 - Connect the equipment into an outlet on a circuit different from that to which the receiver is connected.
 - Consult the dealer or an experienced radio/TV technician for help.
- Changes or modifications not expressly approved by the party responsible for compliance could void the user's authority to operate the equipment.

Declaration of Conformity

Model number: VPC-HD1000

Trade Name: SANYO

Responsible party: SANYO FISHER COMPANY

Address: 21605 Plummer Street, Chatsworth, California 91311

Telephone No.: (818) 998-7322

This device complies with Part 15 of the FCC Rules. Operation is subject to the following two conditions:

- (1) this device may not cause harmful interference, and
- (2) this device must accept any interference received, including interference that may cause undesired operation.

FOR CANADIAN USERS

- This Class B digital apparatus complies with Canadian ICES-003.

FOR EU USERS



Note:

- This symbol mark and recycle system apply only to EU countries and do not apply to countries in other areas of the world.

Your SANYO product is designed and manufactured with high quality materials and components which can be recycled and reused.

This symbol means that electrical and electronic equipment, at their end-of-life, should be disposed of separately from your household waste.

Please dispose of this equipment at your local community waste collection/recycling centre.

In the European Union there are separate collection systems for used electrical and electronic products.

Please help us to conserve the environment we live in!

SANYO FISHER Sales (Europe) GmbH

Stahlgruberring 4, D-81829 München, Germany

SANYO Electric Co., Ltd.

1-1, Sanyo-cho, Daito City, Osaka 574-8534, Japan

FOR RUSSIAN USERS



AR46

This product certified by official certification company which is authorized by Russian Federation.

Symbols used in this manual

- HINT** Points giving some extended instructions or special points to pay attention to.
- CAUTION** Points that require special attention.
- (page xx)** Refer to the page indicated for detailed information.

You may find the answers to questions or problems concerning camera operation in the sections “COMMONLY ASKED QUESTIONS” (page 189) and “TROUBLESHOOTING” (page 197).

SHOOT, PLAY BACK AND SAVE

Preparing the camera

1 Insert the SD Memory Card.

- An SD Memory Card is not included with your camera. Please purchase a commercially sold card.
- In this manual, the SD Memory Card is referred to as the “card”.

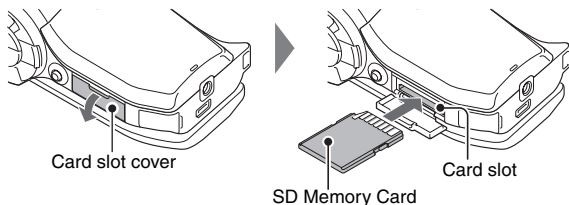

2 Connect the AC adaptor to the camera.

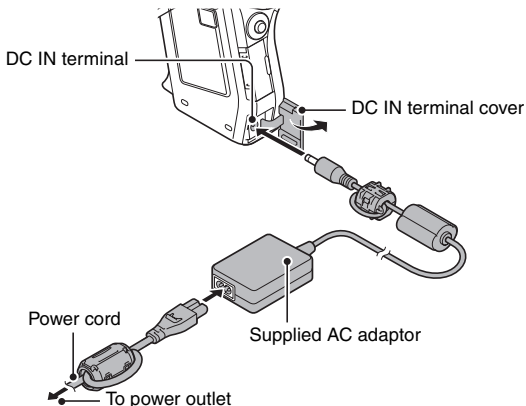

SHOOT, PLAY BACK AND SAVE

Before capturing those important shots, be sure to first take a test shot to confirm that your camera is set up and ready to go

- Sanyo declines any claim for compensation for recorded contents etc. in case of photographing or recording failure due to a chance camera or card flaw.

Shooting

- 1** Set the REC/PLAY switch to REC.



- 2** Press the ON/OFF button for at least 1 second to turn the camera on.

- If the screen to set the date and time appears, press the MENU button 2 times to cancel it.

For how to set the date and time, see page 43.

- 3** Record.

To record a video clip:

- Press the [] button to begin recording a video clip.
- Press the [] button again to end the recording.

To take a photo:

- Press the [] button.
- A still image is captured.

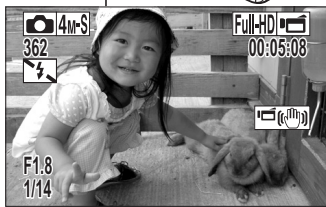
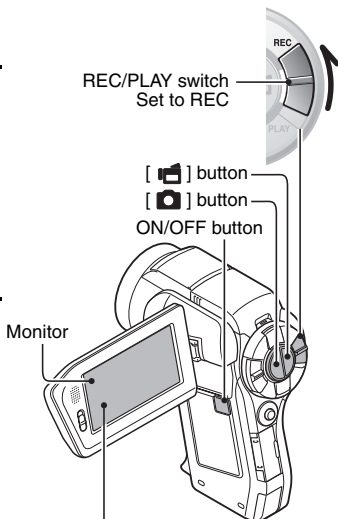

Playback

1 Set the REC/PLAY switch to **PLAY**.

- The display changes to the Playback Screen and the image that was just captured is shown.

2 Toggle the **SET** button to the left or right to display the image you wish to see.

<Video clip playback>

- Video clips are indicated by a video clip pattern along the left and right sides of the screen.
- Press the SET button to start video clip playback.

<To return to the shooting mode>

- Set the REC/PLAY switch to REC.

REC/PLAY switch
Set to PLAY

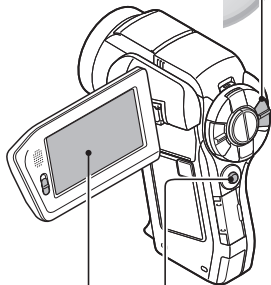

SET button



Video clip pattern

<Example: After recording a video clip>

When you are finished using the camera...

Press the ON/OFF button for at least 1 second to turn the camera off.

SHOOT, PLAY BACK AND SAVE

Burn your recorded video clips onto a DVD (Windows XP)

Using the supplied DVD-ROM (Xacti Software DVD), you can store your captured images on a DVD. Detailed information about the Xacti Software DVD can be found on page 4 in the Xacti Software DVD INSTRUCTION MANUAL.

Install application programs

1 Set the supplied DVD-ROM (Xacti Software DVD) in your computer's DVD drive.

- The installation window opens.

2 Click on [Ulead DVD MovieFactory 5 SE] (hereinafter referred to as "MovieFactory").

- Install the application program with which you can create DVDs (MovieFactory).

<When the [Product Activation] window appears>

- ① Click on "Get activation code from Internet"
- ② Enter your registration information
Email address: Your current email address
Password: Create a password
Serial number: Enter the serial number from the DVD-ROM (supplied) sheet.

<For registered Ulead members>

- Enter your email address, password, and the serial number, and click on the "Sign In" button.

<For non-registered Ulead members>

- Click on the "Create a New Account" button, enter your registration information, and click on the "Submit" button.
- ③ The activation code will appear in a pop-up window. Enter this number in the [Product Activation] window, and click on the "Activate" button.
- After clicking on an application program, follow the instructions shown on the monitor to install the program.

3 In the installation window, click on [Finish] and remove the DVD-ROM from the computer's DVD drive.

<About the Kodak online service>

- When the installation window closes, a dialog box to connect to the website introducing Kodak's online service appears. Check the [No thanks!] option button, and then click on the [OK] button.

Connect your camera to a computer

Connect your camera to a computer, and copy the desired files to the computer.

1 Use the supplied dedicated USB interface cable to connect your camera to the computer.

2 Turn on the camera.

- The USB Connection Screen appears on the camera's monitor.

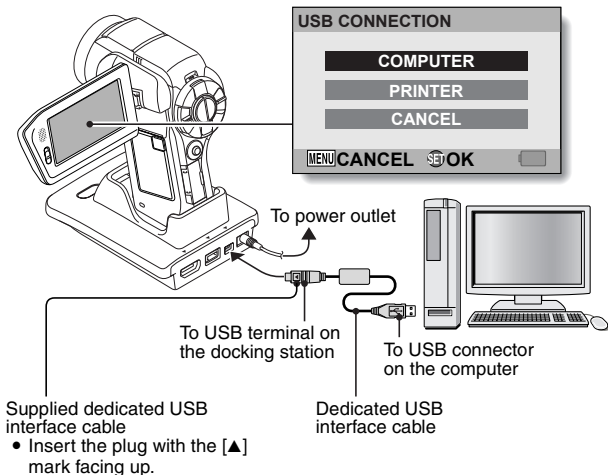

SHOOT, PLAY BACK AND SAVE

- 3** Select **[COMPUTER]**, and press the **SET** button.
 - The screen to select the computer connection mode appears.
- 4** Select **[CARD READER]**, and press the **SET** button.
 - The message [Found New Hardware] appears in the task tray, showing that the camera is recognized as a drive.
 - The card is recognized (mounted) as a disk, and the [XACTI (E:)] icon appears in the [My Computer] window.
 - * The drive name (E:) may be different on your computer.
- 5** Copy the files from the card to the computer's hard disk.
 - The data recorded with your camera are stored in the following folder. You can specify the folder on the hard disk to which to copy the files.
XACTI (E:)\DCIM****SANYO
(**** represents numbers [page 12 in the Xacti Software DVD INSTRUCTION MANUAL]).

Burn video clips onto a DVD

1 Click on your desktop's [Ulead DVD MovieFactory 5 Launcher] icon to run MovieFactory.

- The MovieFactory launcher appears.
- If the product registration screen appears, select [Register Later].

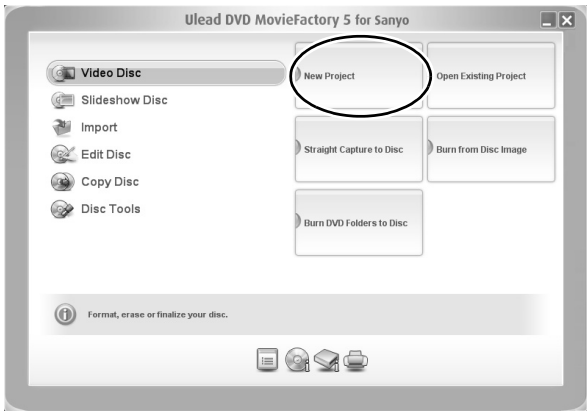

SHOOT, PLAY BACK AND SAVE

- 2** Click on [New Project].
- The [Create Video Disc] window opens.

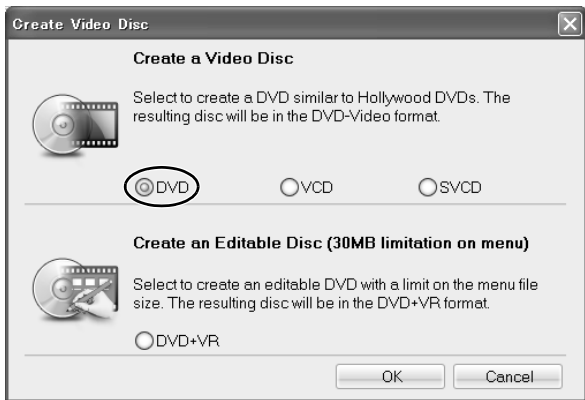

- 3** Set the [DVD] option to ON, and click on the [OK] button.
- The [Select source and import] window opens.

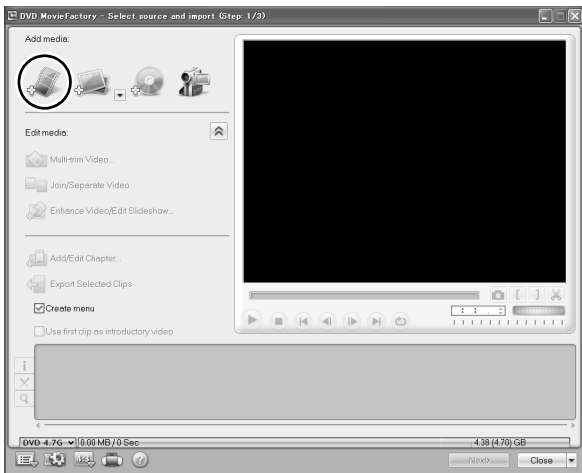

- 4** Click on the [Add video files] icon.

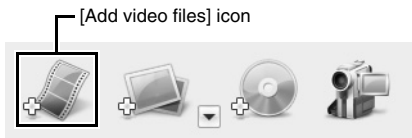

- The [Open Video File] dialog box opens.
- Open the folder that contains the video files.

SHOOT, PLAY BACK AND SAVE

5 Select the video clip files to burn onto the DVD.

- Select the files you wish to burn onto the DVD by clicking on them.
- To select multiple files, click on the individual files while holding down the [Ctrl] button. If you select one file, hold down the [Shift] button and click on another file in the list, all the files in between are also selected.

6 Click on the [Open] button.

<When one video clip is selected>

- The [Open Video File] dialog box closes.

<When multiple video clips are selected>

- The [Rearrange clip order] dialog box opens.
- You can drag the clip file names to change the video clip playback order.
- Click on the [OK] button, and the [Rearrange clip order] dialog box closes.
- The file selected in step 5 appears in the [Select source and import] window.

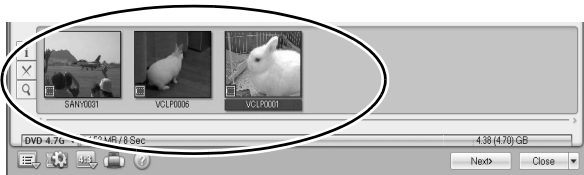

-
- 7** Click on the [Next] button.
- The window to edit the title page of your DVD appears.

-
- 8** Set your desired title page, and click on the [Next] button.
- The window to confirm the title page appears.

-
- 9** Click on the [Next] button.
- The [Press Burn button to create a DVD] window opens.

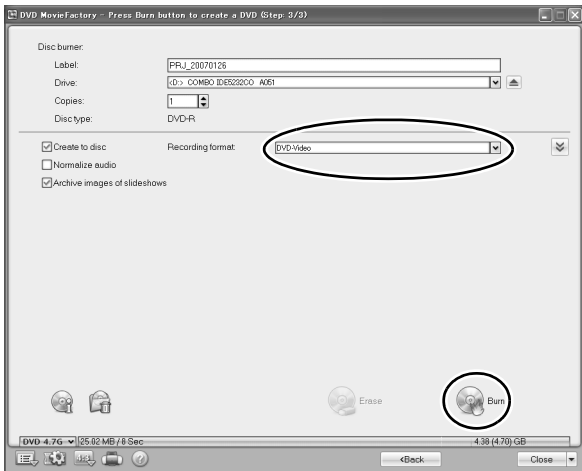

-
- 10** Set the [Recording format] to [DVD-Video].

-
- 11** Set a blank DVD in your computer's disc burner, and click on the [Burn] icon.
- A confirmation dialog box appears.



SHOOT, PLAY BACK AND SAVE

12 Click on the [OK] button.

- Disc writing begins.
- After burning the disc, a dialog box shows that burning is complete.

13 Click on the [OK] button.

- The DVD drive tray opens for you to remove the disc.

<About saving projects>

- After burning a disc, a save project dialog box appears. If you wish to use the settings for the current project in subsequent projects, you should save them. If you will not use the settings in subsequent projects, it is not necessary to save them.

14 Click on the [OK] button.

- You are returned to the MovieFactory launcher.

15 Click on the exit MovieFactory button [x].

- The DVD is completed.
- MovieFactory is exited.

How was that? The convenient accessories not only let you immediately view images captured with the camera, but you can also upload images to your computer and create your original DVDs. Read the following explanations to find out how you can fully enjoy your camera's digital movie feature.



CONTENTS

QUICK SEARCH BY OPERATION	6
CHECKING THE INCLUDED ACCESSORIES	11
How to use the accessories	13
Separately sold accessories	15
Media cards that can be used with this camera	16
GETTING THE MOST OUT OF YOUR CAMERA	17
High-quality images with “full high definition”	17
Includes SIMPLE mode for quick-and-easy operation	18
Image stabilizer for sharp pictures	18
Sharp face shots	19
Xacti Library feature	19
SYSTEM MAP	21

■ SETUP

PARTS NAMES	22
Camera	22
Docking station	25
Remote control unit	26
INSTALLING THE CARD	27
PREPARING THE DOCKING STATION	29
PREPARING THE REMOTE CONTROL UNIT	30
Prepare the battery	30
How to use the remote control unit	31
PREPARING THE POWER	33
Charging the battery pack	33
When using a power outlet	37
About recharging	39
TURNING THE CAMERA ON AND OFF	40
Turning on the camera	40
Turning on the camera when the power save (sleep) mode is active	41
Turning off the camera	41
DATE AND TIME SETTING	43
SWITCHING BETWEEN THE SHOOTING MODE AND PLAYBACK MODE	46

SIMPLE MODE/NORMAL MODE	47
About the SIMPLE mode and NORMAL mode	47
Switching between the SIMPLE and NORMAL modes	48
Accessing/exiting the SIMPLE/NORMAL Mode Menu Screen	49
Overview of the SIMPLE Mode Setting Screen	55
Overview of the NORMAL Mode Setting Screen	59
FULL AUTO MODE	67

■ SIMPLE

SHOOTING

BEFORE TAKING PICTURES	68
For best results	68
Using the autofocus	69
Select the recording size	71
Select the focus setting	72
Hints for taking pictures	73
VIDEO CLIP RECORDING	74
SHOOTING SINGLE SHOTS	75
Using the flash	77
SHOOT A STILL IMAGE WHILE RECORDING A VIDEO CLIP	79
MACRO-PHOTOGRAPHY (ZOOM)	81
SHOOTING AND PLAYBACK WITH THE REMOTE CONTROL UNIT	82

PLAYBACK

PLAYING BACK VIDEO CLIPS AND STILL IMAGES	83
SLIDESHOW PLAYBACK	86
PLAYBACK VOLUME	87
DELETING FILES	88
PLAYBACK MODES	90
9-image display playback	90
Selecting the playback folder	91
Magnifying (zooming in) the image	92

■ NORMAL

SHOOTING

RECORDING SIZE	93
Movies	93
Still images	94
Sequential shots	95
Audio recording	96
SCENE SELECT	99
FILTERS	101

CONTENTS

FLASH OPERATION	102
SELF-TIMER	103
MOTION COMPENSATION (IMAGE STABILIZER)	105
Compensate for camera shake when recording movies	105
Compensate for camera shake when shooting still images	105
FOCUS RANGE	107
How to use the manual focus	108
FOCUS MODE	109
LIGHT-MEASURING MODE SETTING	110
ISO SENSITIVITY	111
WHITE BALANCE	113
EXPOSURE SETTING	114
DIGITAL ZOOM SETTING	116
FACE CHASER	117
HIGH SENSITIVITY MODE	118
EXPOSURE COMPENSATION	119

PLAYBACK

SLIDESHOW PLAYBACK	120
FILE PROTECT	122
PRINTING INSTRUCTIONS	123
Display the Printing Instructions Screen	123
Specifying date imprinting and print quantities	125
Index print	127
Clearing all the printing instructions	128
ROTATE STILL IMAGE	129
REDUCE STILL IMAGE SIZE (RESIZE)	130
EXTRACTING ONE FRAME FROM A VIDEO CLIP	131
EDITING VIDEO CLIPS	132
Procedure to cut (extract) a portion of a video clip	132
Procedure to join video clips	133
Video clip cutting (extracting)	134
Joining video clips	137
DISPLAYING FILE PROPERTIES (INFORMATION SCREEN)	140

■ OPTION SETTINGS

DISPLAY THE OPTION SETTING MENU	141
SCREEN DISPLAY	142
SELECT THE STARTUP DISPLAY	143
OPERATION SOUNDS	144
POST-VIEW DISPLAY SETTING	146
SPECIFY A FOLDER TO SAVE FILES	147

ASSIGN SET BUTTON FUNCTIONS	148
NOISE-REDUCTION FUNCTION	150
ADJUST THE IMAGE QUALITY	151
FLICKER-REDUCTION	152
MONITOR BRIGHTNESS	153
ADJUST THE VOLUME OF AN EXTERNAL MICROPHONE	154
SCREEN LANGUAGE	155
TV OUTPUT SETTING	156
POWER SAVE FUNCTION	160
FILE NO. MEMORY	162
FORMATTING A CARD	165
RESETTING THE CAMERA SETTINGS	167
CHECKING THE REMAINING CARD MEMORY	168
Checking the remaining number of images and video recording time	168
For audio recordings	168
CHECKING THE REMAINING BATTERY PACK CHARGE	170

■ OTHER DEVICES AND CONNECTIONS

CONNECTING TO A TV

CONNECTING TO A STANDARD VIDEO INPUT TERMINAL	172
ENJOY HIGHER IMAGE QUALITY	173
Connect to the S-VIDEO terminal	173
Connect to the 480p/720p/1080i terminal	174
Connecting to the HDMI terminal	175
PLAYING BACK ON A TV	176
Xacti Library	177

CONNECTING TO A PRINTER

PictBridge MODE	178
PRINTING	180
Printing selected images	180
Printing all images	182
Making an index print	183
Printing images according to printing instructions (requested images)	184
Changing the printer settings	185

OTHER CONNECTIONS

CONNECTING A MICROPHONE/HEADPHONES	187
SHOE MOUNT	188

CONTENTS

■ APPENDICES

COMMONLY ASKED QUESTIONS	189
TROUBLESHOOTING	197
Camera	197
Docking station	206
Notes regarding the Scene Select feature and filters	208
SPECIFICATIONS	210
Camera	210
Camera connectors	214
Battery life	215
Possible No. of Images/Possible Shooting Time/ Possible Recording Time	216
Docking station	217
Remote control unit	217
Concerning the multi-indicator and blue LED indicator	218
Supplied AC adaptor	219
Supplied Li-ion battery pack	219
Others	220
Before capturing those important shots, be sure to first take a test shot to confirm that your camera is set up and ready to go	221
HINTS FOR TAKING PICTURES	222

QUICK SEARCH BY OPERATION

Your camera has an abundance of convenient features and functions. From creating precisely the photo you want, to viewing images using various techniques, you can locate the exact operation for your purposes in the following table.

Shooting/recording		
Basic operation	Convenient functions	Additional functions
Getting started shooting/recording <ul style="list-style-type: none"> • "VIDEO CLIP RECORDING" on page 74 • "SHOOTING SINGLE SHOTS" on page 75 • "Sequential shots" on page 95 • "Audio recording" on page 96 	Log the date and time of your photos <ul style="list-style-type: none"> • "DATE AND TIME SETTING" on page 43 Zoom in on the subject <ul style="list-style-type: none"> • "MACRO-PHOTOGRAPHY (ZOOM)" on page 81 Close-up photography <ul style="list-style-type: none"> • "Select the focus setting" (super macro mode) on page 72 • "FOCUS RANGE" (super macro mode) on page 107 	For more accurate focus <ul style="list-style-type: none"> • "How to use the manual focus" (manual focus) on page 108 Set the focus to a narrow range <ul style="list-style-type: none"> • "FOCUS MODE" on page 109 Reduce noise when recording <ul style="list-style-type: none"> • "NOISE-REDUCTION FUNCTION" on page 150
Optimize the photo quality <ul style="list-style-type: none"> • "Select the recording size" on page 71 • "RECORDING SIZE" on page 93 	Reduce video clip flicker <ul style="list-style-type: none"> • "FLICKER-REDUCTION" on page 152 Set the camera's color/contrast characteristics <ul style="list-style-type: none"> • "ADJUST THE IMAGE QUALITY" on page 151 	
Capture fast-moving subjects <ul style="list-style-type: none"> • "SCENE SELECT" (sports mode) on page 99 		
Suppress camera shake effect <ul style="list-style-type: none"> • "Compensate for camera shake when recording movies" on page 105 • "Compensate for camera shake when shooting still images" on page 105 		
Shoot in dark conditions <ul style="list-style-type: none"> • "EXPOSURE COMPENSATION" on page 119 • "Using the flash" on page 77 • "FLASH OPERATION" on page 102 • "SCENE SELECT" (night view portrait mode/fireworks mode/lamp mode) on page 99 		
	Increase the camera's sensitivity <ul style="list-style-type: none"> • "ISO SENSITIVITY" on page 111 • "HIGH SENSITIVITY MODE" on page 118 	

QUICK SEARCH BY OPERATION

Shooting/recording		
Basic operation	Convenient functions	Additional functions
Photographing people <ul style="list-style-type: none"> • “SCENE SELECT” (portrait mode/night view portrait mode) on page 99 • “FILTERS” (cosmetic filter) on page 101 • “Using the flash” (red-eye reduction) on page 77 • “FLASH OPERATION” (red-eye reduction) on page 102 Sharp face shots <ul style="list-style-type: none"> • “FACE CHASER” on page 117 		
Simplified operation for shooting/playback <ul style="list-style-type: none"> • “SIMPLE MODE/NORMAL MODE” on page 47 • “FULL AUTO MODE” on page 67 		
Photographing landscapes <ul style="list-style-type: none"> • “SCENE SELECT” (landscape mode) on page 99 		
Take a self-photo <ul style="list-style-type: none"> • “SELF-TIMER” on page 103 		
	Make images lighter or darker <ul style="list-style-type: none"> • “EXPOSURE COMPENSATION” on page 119 • “HIGH SENSITIVITY MODE” on page 118 	Measure the brightness of a specific area <ul style="list-style-type: none"> • “LIGHT-MEASURING MODE SETTING” on page 110 Adjust the camera’s sensitivity <ul style="list-style-type: none"> • “ISO SENSITIVITY” on page 111 For a more precise exposure setting <ul style="list-style-type: none"> • “EXPOSURE SETTING” (manual exposure control) on page 114
	Change the color of the images <ul style="list-style-type: none"> • “FILTERS” (monochrome filter/sepia filter) on page 101 	Make white appear natural <ul style="list-style-type: none"> • “WHITE BALANCE” on page 113

Playback		
Basic operation	Convenient functions	Additional functions
Getting started viewing images <ul style="list-style-type: none"> • "PLAYING BACK VIDEO CLIPS AND STILL IMAGES" on page 83 	Adjust the speaker volume <ul style="list-style-type: none"> • "PLAYBACK VOLUME" on page 87 Search for image/ audio files <ul style="list-style-type: none"> • "9-image display playback" on page 90 • "Selecting the playback folder" on page 91 Magnify an image <ul style="list-style-type: none"> • "Magnifying (zooming in) the image" on page 92 	Change the angle of view <ul style="list-style-type: none"> • "ROTATE STILL IMAGE" on page 129
<ul style="list-style-type: none"> • "Audio playback" on page 97 	Adjust the speaker volume <ul style="list-style-type: none"> • "PLAYBACK VOLUME" on page 87 	
Continuous playback <ul style="list-style-type: none"> • "SLIDESHOW PLAYBACK" on page 86 and 120 		
Adjust the monitor brightness <ul style="list-style-type: none"> • "MONITOR BRIGHTNESS" on page 153 		
Playback on a TV <ul style="list-style-type: none"> • "PLAYING BACK ON A TV" on page 176 Set the TV system <ul style="list-style-type: none"> • "TV OUTPUT SETTING" on page 156 How to use Xacti Library <ul style="list-style-type: none"> • "Xacti Library" on page 177 		

QUICK SEARCH BY OPERATION

File managing/processing		
Basic operation	Convenient functions	Additional functions
Search for image/audio files <ul style="list-style-type: none">• “9-image display playback” on page 90• “Selecting the playback folder” on page 91		
Delete files <ul style="list-style-type: none">• “DELETING FILES” on page 88	Protect files from accidental erasure <ul style="list-style-type: none">• “FILE PROTECT” on page 122 Format a card <ul style="list-style-type: none">• “FORMATTING A CARD” on page 165	
Delete a part of a video clip and join video clips <ul style="list-style-type: none">• “EDITING VIDEO CLIPS” on page 132		
Specify the number of prints, index print, and date imprint <ul style="list-style-type: none">• “PRINTING INSTRUCTIONS” on page 123		
View the settings that were in effect when the image/audio files were recorded <ul style="list-style-type: none">• “DISPLAYING FILE PROPERTIES (INFORMATION SCREEN)” on page 140		

Using with a computer		
Basic operation	Convenient functions	Additional functions
Use the camera as a card reader <ul style="list-style-type: none"> • "USING AS A CARD READER" on page 9 in the Xacti Software DVD INSTRUCTION MANUAL 		
Copy files from your camera to a computer <ul style="list-style-type: none"> • "Connect your camera to a computer" on page viii 	Using with Windows Vista <ul style="list-style-type: none"> • "CONNECTING IN THE MTP MODE" on page 14 in the Xacti Software DVD INSTRUCTION MANUAL 	
Burn files copied to the computer onto a DVD <ul style="list-style-type: none"> • "Burn your recorded video clips onto a DVD (Windows XP)" on page vii 		
Playback <ul style="list-style-type: none"> • "About video clip files recorded with this camera" on page 13 in the Xacti Software DVD INSTRUCTION MANUAL 		
Using as a webcam <ul style="list-style-type: none"> • "Using as a PC camera" on page 16 in the Xacti Software DVD INSTRUCTION MANUAL 		
Record an image of the computer screen <ul style="list-style-type: none"> • "SCREEN CAPTURE" on page 25 in the Xacti Software DVD INSTRUCTION MANUAL 		

CHECKING THE INCLUDED ACCESSORIES

- Soft case (page 14): 1

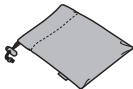

- Xacti Software DVD (DVD-ROM) (page 4 in the Xacti Software DVD INSTRUCTION MANUAL): 1



- Docking station (pages 25 and 29): 1

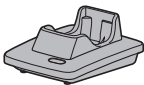

- Dedicated USB interface cable (page 7 in the Xacti Software DVD INSTRUCTION MANUAL): 1



- HDMI cable (page 175): 1
Included with model VPC-HD1000EX. Not included with other models.

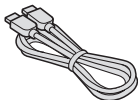

- Handstrap (page 13): 1

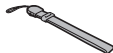

- Li-ion battery pack (page 34): 1

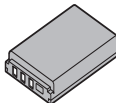

- Dedicated S-AV interface cable (pages 172 and 173): 1



- Dedicated component cable (page 174): 1

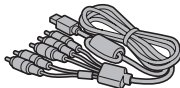

- AC adaptor and power cord (pages 29, 37 and 38): 1

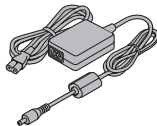

- Remote control unit (pages 26, 30 to 32 and 82): 1

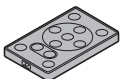

FOR CALIFORNIA, U.S.A. ONLY
 Perchlorate Material - special handling may apply.
 The lithium battery used in this camera contains perchlorate material, which may require special handling. See www.dtsc.ca.gov/hazardouswaste/perchlorate.

- Lens cap (page 13): 1

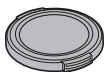

- Dedicated USB converter cable: 1
 - For use with the Xacti Library feature

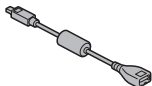

- Microphone connection cable (page 187): 1

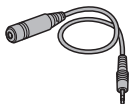

- Cores: (6)

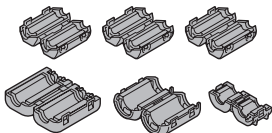

- “SAFETY MANUAL” (safety precautions booklet) Please read this booklet carefully before using the camera.



- Xacti Library Instruction Manual



- Quick Guide Included with model VPC-HD1000GX. Not included with other models.



CHECKING THE INCLUDED ACCESSORIES

How to use the accessories

■ Handstrap

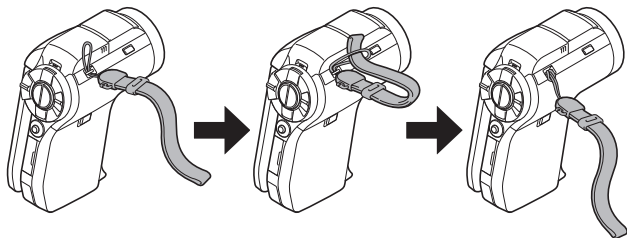

■ Lens cap

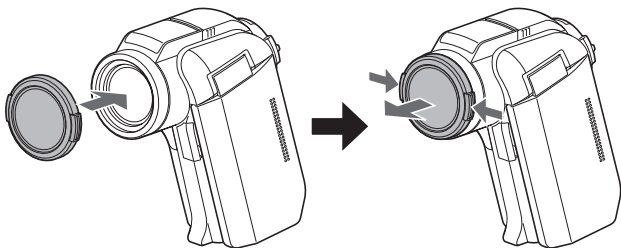

■ Soft case

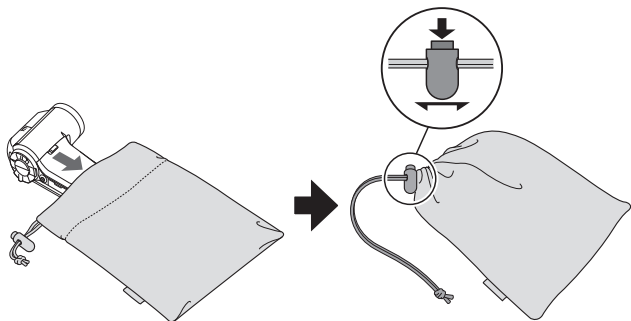

CHECKING THE INCLUDED ACCESSORIES

Separately sold accessories

- **HDMI cable VCP-HDMI01**
Cable for connecting to the HDMI terminal on the docking station.
- **Lithium-ion Battery Charger VAR-L50**
Battery charger for the supplied or separately sold lithium-ion battery pack (DB-L50A).
- **Lithium-ion Battery DB-L50A**
Same model as the supplied lithium-ion battery pack.
- **Wide Conversion Lens VCP-L07W**
Expand your camera's wide-angle range.
- **Tele Conversion Lens VCP-L16T**
Make distant objects appear closer.
- **External Microphone VCP-MP01**
Connect this stereo microphone to the external microphone jack [MIC].
- **Semi Fish-eye Lens VCP-L04F**
For wide-angle shots close to the fisheye lens.

Media cards that can be used with this camera

The type of card that can be inserted into and used with this camera is:

- SD Memory Card

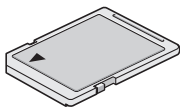

GETTING THE MOST OUT OF YOUR CAMERA

Your digital movie camera can record video clips in full high vision. It includes an operation mode that lets even novice shutterbugs record and play back without getting flustered, as well as software with which you can easily create your original DVDs. In addition, it comes with the “Xacti Library” feature for saving recorded data to hard disk and managing files without using a computer.

High-quality images with “full high definition” (pages 71 and 93)

Your camera can capture full high definition (full HD) 1920 × 1080-pixel, 60 fields/s video clips. Also, the H.264/MPEG-4 AVC standard is used for formatting video files. You get both compact file size and high picture quality in one high-performance camera.

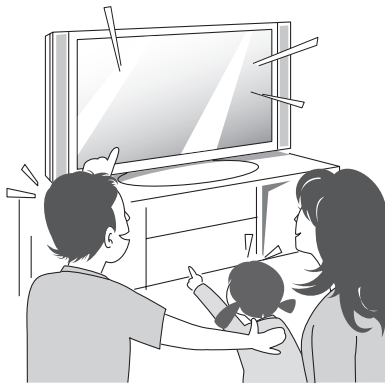

Includes SIMPLE mode for quick-and-easy operation (page 47)

Select from two shooting/playback modes: the “SIMPLE mode” for users new to the camera, and the “NORMAL mode” for full use of all the camera’s many features and functions.

Example:



<SIMPLE Mode Shooting Menu>

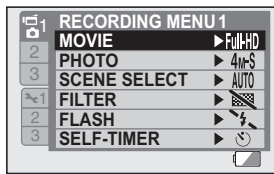

<NORMAL Mode Shooting Menu>

Image stabilizer for sharp pictures (page 105)

Your camera can compensate for the camera shake that results in blurry images when you try to capture a fast-moving subject or zoom in on a subject. Image stabilizer functions for both video clip recording and still image shots are on board.



GETTING THE MOST OUT OF YOUR CAMERA

Sharp face shots (page 117)

Your camera is equipped with a face recognition feature which detects the subject's face even when slightly lit from behind or in dim surroundings and automatically adjusts the focus and brightness to compensate. Now those otherwise perfect photos that are marred by shadowed faces can be minimized.

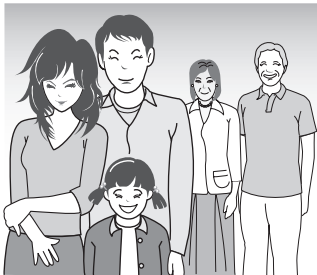

Xacti Library feature (page 177)

The Xacti Library feature allows you to save files recorded with your camera to a large-capacity hard disk without using a computer and play them back on your TV. No computer operation is involved. You can view full high-definition images right on your TV screen.

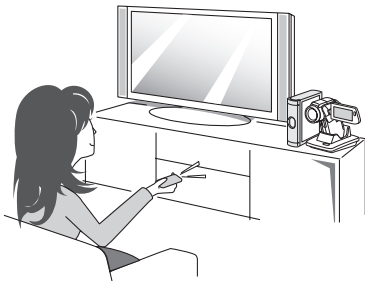

Lots of accessories for optimal use of your captured images (pages 21 and 4 in the Xacti Software DVD INSTRUCTION MANUAL)

Use the accessory cables to view images on a TV or computer. Or connect the camera directly to a printer to make prints of your photos. And with the software in the supplied DVD-ROM (Xacti Software DVD), you can create your original DVDs and CDs.



SYSTEM MAP

You can connect the camera to various devices to expand its capabilities.

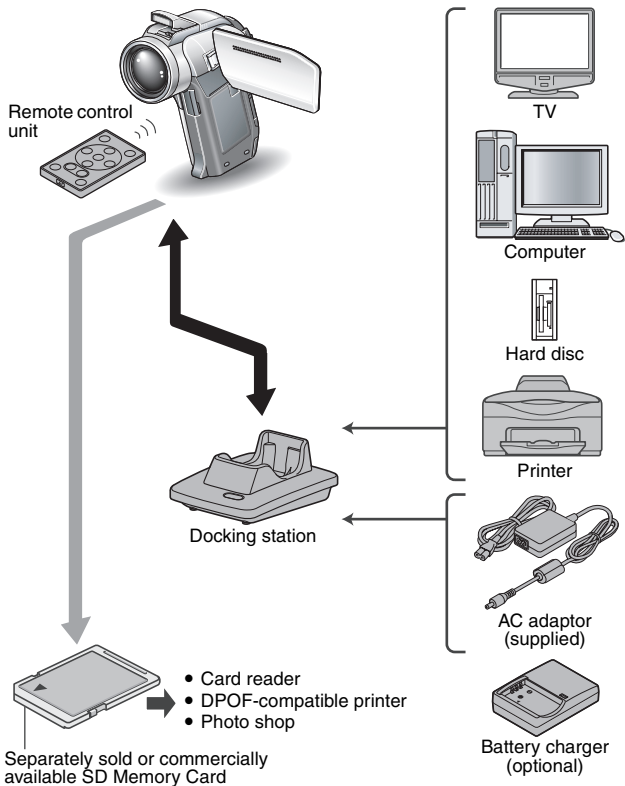

PARTS NAMES

Camera

Front

Flash

- Extends when the flash button [⚡] is pressed.

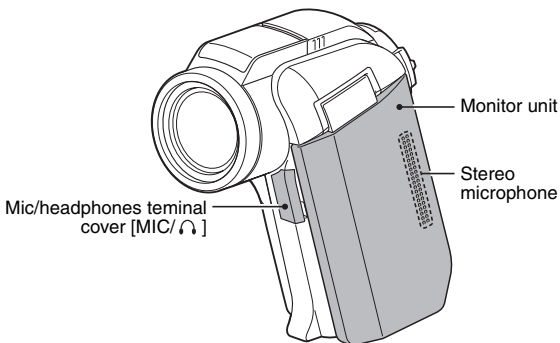
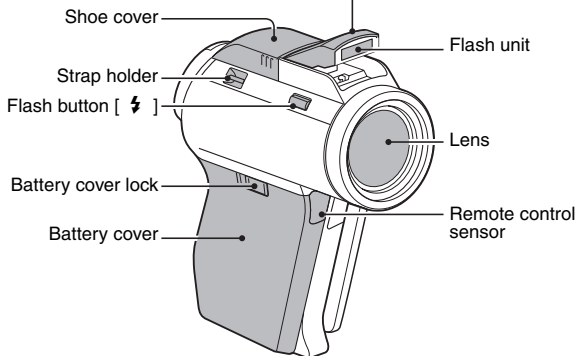

PARTS NAMES

<To open the monitor unit>

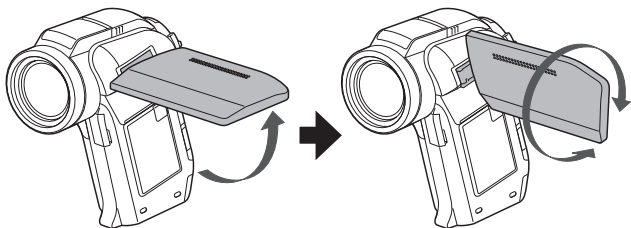

Rear

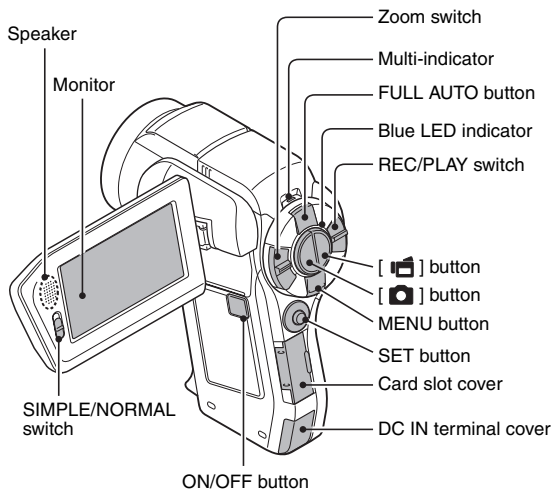

Bottom

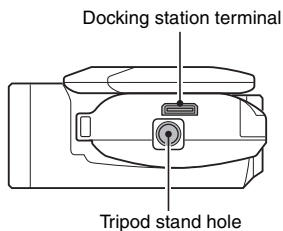

PARTS NAMES

Docking station

Front

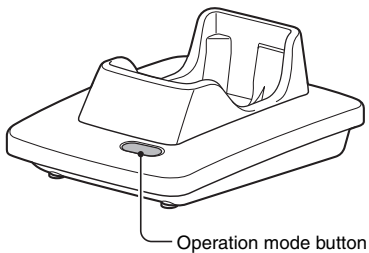

Rear

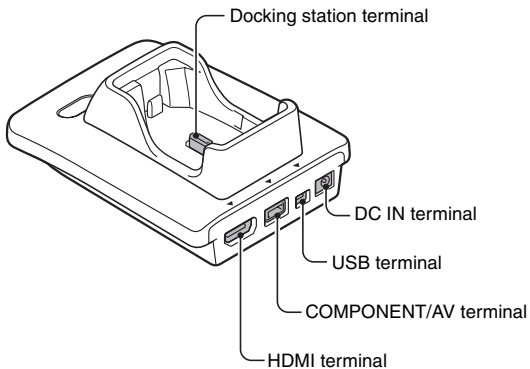

Remote control unit

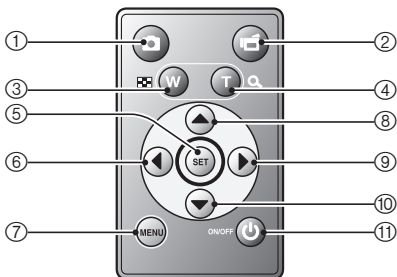

<In the shooting mode>

- 1 [] button
- 2 [] button
- 3 Works the same as pushing zoom switch toward the [W] ([]) side
- 4 Works the same as pushing zoom switch toward the [T] ([]) side
- 5 SET button
- 6 Works the same as toggling SET button to the left
- 7 MENU button
- 8 Works the same as toggling SET button up
- 9 Works the same as toggling SET button to the right
- 10 Works the same as toggling SET button down
- 11 ON/OFF button
 - Works only when the camera is set in the docking station.

<In the playback mode>

- 1 [] button
- 2 (inoperative)
- 3 Works the same as pushing zoom switch toward the [W] ([]) side
- 4 Works the same as pushing zoom switch toward the [T] ([]) side
- 5 SET button
- 6 Works the same as toggling SET button to the left
- 7 MENU button
- 8 Works the same as toggling SET button up
- 9 Works the same as toggling SET button to the right
- 10 Works the same as toggling SET button down
- 11 ON/OFF button
 - Works only when the camera is set in the docking station.

INSTALLING THE CARD

Be sure to format a newly purchased card or one that was used in another device before using it in your camera (page 165). If an unformatted card is used, the card itself may become unusable.

- 1** Open the card slot cover, and insert the card in the card slot.

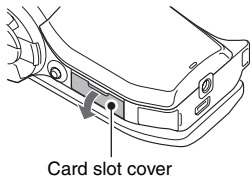

- 2** Insert the card all the way in.
- Firmly insert the card until it clicks into place.

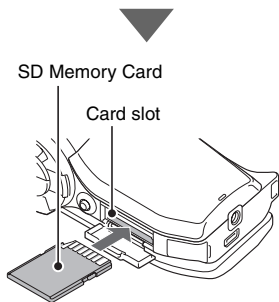

- 3** Close the card slot cover.

<To remove the card...>

- To remove the card, press it in, and then release. The card will protrude slightly, and you can then pull it out.

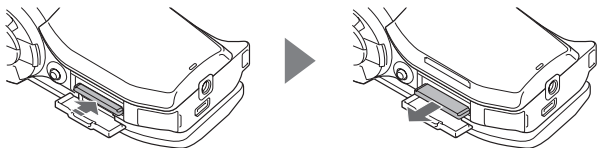

CAUTION

Do not attempt to forcibly remove the card

- Doing so may damage the card or the stored files.

If the multi-indicator is flashing red...

- Never remove the card when the multi-indicator is flashing red, as doing so may result in loss of files stored in the card.

PREPARING THE DOCKING STATION

The supplied docking station is used to connect your camera to a computer, printer or TV, as well as to charge the battery pack installed in the camera.

1 Connect the docking station to a power outlet.

- Use the supplied AC adaptor and power cord.

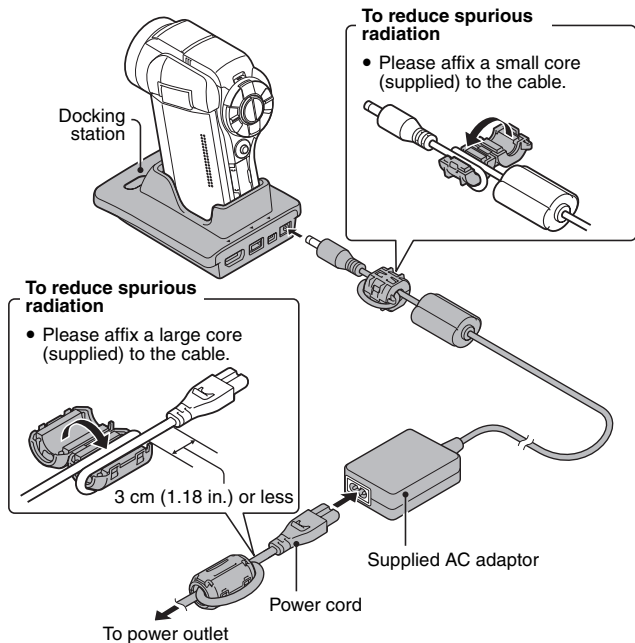

PREPARING THE REMOTE CONTROL UNIT

The remote control unit can be used to take pictures and play them back with the camera.

Prepare the battery

A battery is already installed in the remote control unit at the time of purchase.

1 Pull out the battery insulating sheet.

- The remote control unit becomes operable when the insulating sheet is removed.

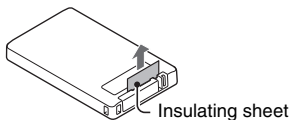

Replacing the remote control unit battery

Follow the procedure below to replace the CR2025 battery used in the remote control unit approximately every year (differing depending on the amount of use).

Remove the old battery

- 1 Pull out the battery slot.
 - While pressing the tab, pull the battery slot out.

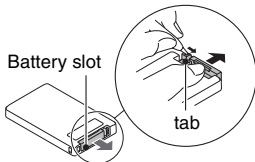

- 2 Remove the battery.

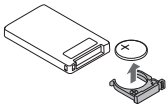

Insert a new battery

- 1 Insert a new battery.
 - First wipe the battery with a clean, dry cloth, and insert it with the (+) mark facing up.

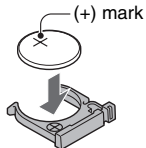

- 2 Re-insert the battery slot.

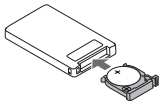

PREPARING THE REMOTE CONTROL UNIT

How to use the remote control unit

The remote control unit can be used at an angle that is displaced 15 degrees horizontally from the remote control sensor on the front of the camera, at a distance of up to 7 meters (22.97 ft.). When operating the remote control unit, remove any object that may obstruct the path between it and the remote control sensor.

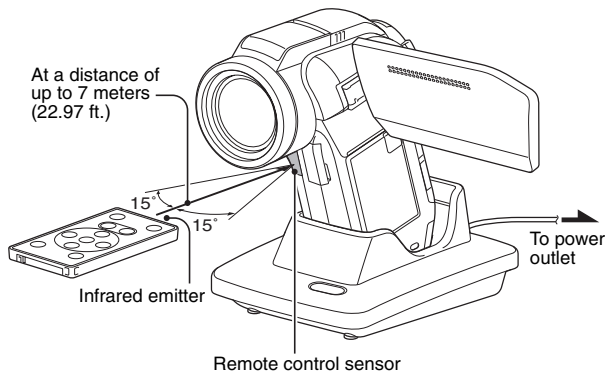

CAUTION

- If the remote control unit is operated in sunlight or under inverter lighting, the remote control receiving range may become shorter. This is a characteristic of the infrared remote control unit and is not a defect. To avoid this malfunction when operating the remote control unit, take care to shield the remote control sensor from strong light.

Changing the remote control code

The remote control unit will also work with other Sanyo cameras that can be operated by infrared remote control. When more than one camera is present, it is recommended to change the remote control code to ensure that only the intended camera operates when the remote control unit is used. The remote control code is set to "RC CODE 1" at the time of purchase.

<Changing the remote control code from "RC CODE 1" to "RC CODE 2">

- 1** Aim the infrared emitter at the remote control sensor on the docking station.
- 2** Simultaneously press the MENU button and the [] button for at least 3 seconds.
- 3** Press a button on the remote control unit and check that the camera is receiving correctly.
 - The remote control codes are retained even if the batteries in the remote control unit or camera are replaced.
 - If the remote control codes for the remote control unit and the camera and do not match, the remote control unit cannot be used to operate the camera.

<Resetting the remote control code to "RC CODE 1">

- 1** Aim the infrared emitter at the remote control sensor on the docking station.
- 2** Simultaneously press the MENU button and the [] button for at least 3 seconds.

PREPARING THE POWER

Please charge the supplied battery pack before using it. Power to the camera can also be supplied from a power outlet if the docking station or the AC adaptor is used.

Charging the battery pack

- 1** While pressing the battery cover lock, slide it (①), and pull out the battery cover toward the bottom of the camera (②).
- The battery cover comes off.

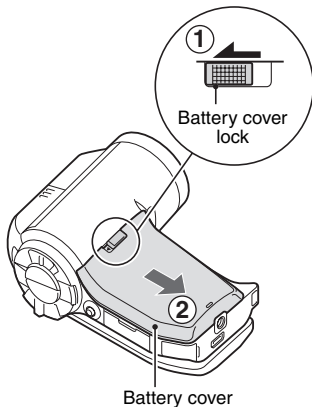

2 Insert the battery pack.

- Take care that it is positioned correctly.

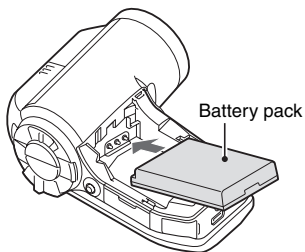

3 Replace the battery cover.

<To remove the battery pack...>

- Raise the edge of the battery pack to remove it.

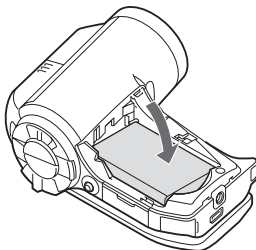

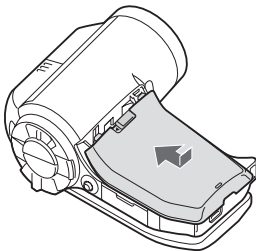
4 Prepare the docking station (page 29).

PREPARING THE POWER

5 Close the camera's monitor unit, and set the camera in the docking station.

- Set the camera securely, making sure that the camera is correctly oriented in relation to the terminal contacts in the docking station.
- Charging begins when the camera is set in the docking station.
- During charging, the multi-indicator is lit red. When charging is completed, the indicator turns off.
- If the multi-indicator flashes red, it indicates that the battery pack is defective or the camera is not correctly set in the docking station. Reset the camera correctly in the docking station.
- The charging time is approx. 200 minutes.
- The AC adaptor (supplied) can be connected to the camera's DC IN terminal to charge the battery.

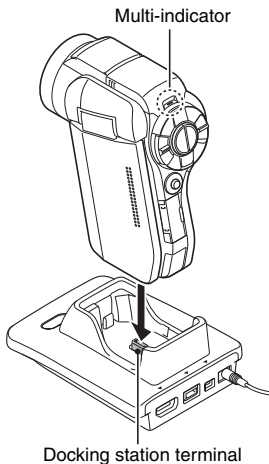

CAUTION**Using the camera when it is set in the docking station...**

- You can photograph and view images while the camera is set in the docking station.

Do not charge the battery pack immediately after the camera has been in continuous use for a long time

- The battery pack becomes hot when the camera is used continuously for a long time. If you attempt to charge the battery pack in this state, the multi-indicator may flash red and it may not be possible to charge the battery pack. Wait until the battery pack has cooled down before attempting to charge it.

Does the battery pack appear swollen?

- The lithium-ion battery used in this camera may expand slightly when stored in a hot environment or repeatedly used, but this is not a safety hazard.

HINT**About the internal backup battery**

- This camera's internal battery serves to maintain the date and time settings, as well as the shooting settings. The backup battery will be fully charged when the battery pack is kept in the camera continuously for about 2 days. In the fully charged state, the backup battery will maintain the camera settings for about 7 days.

When not using the camera for a long time, remove the battery pack

- A small amount of power is still used even if the camera is turned off, and it is therefore recommended that the battery pack be removed from the camera if it is not going to be used for a long time. Note that when the battery pack is removed for a long period, the time and date settings may be cleared. Before using your camera again, be sure to confirm that the camera settings are correct.

To prolong the life of the battery pack

- Although the battery pack is an expendable item, you can maximize the life of the battery by heeding the following suggestions.
 - Do not leave the battery under the hot summer sun or exposed to other high-temperature environments.
 - Do not continually recharge the battery when it is already fully charged. After fully charging it once, for example, use it for a while to partially discharge it before recharging it again.
 - When the battery is not to be used for a long time, if possible store the partially charged (not fully charged) battery in a cool environment.

PREPARING THE POWER

When using a power outlet

Power to the camera can be supplied from a power outlet if the docking station or the AC adaptor is used.

Using the AC adaptor

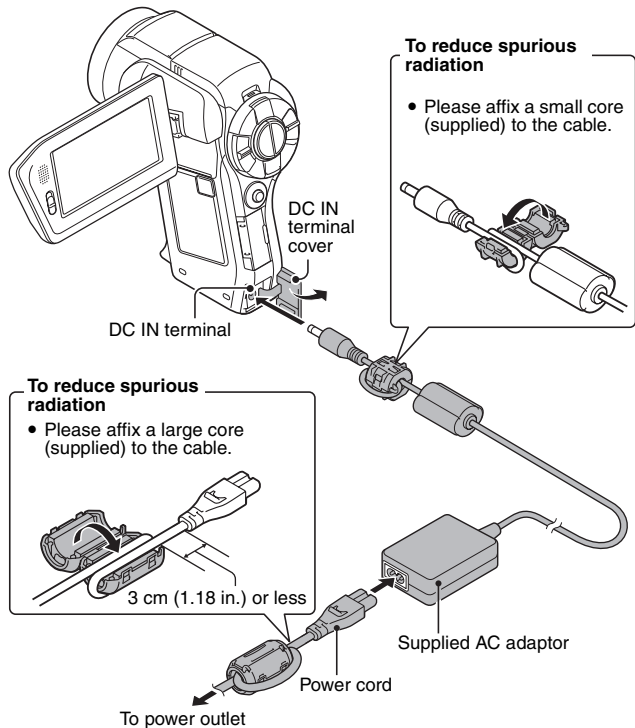

Using the docking station

Use the supplied AC adaptor and power cord to connect the docking station to a power outlet, and set the camera in the docking station.

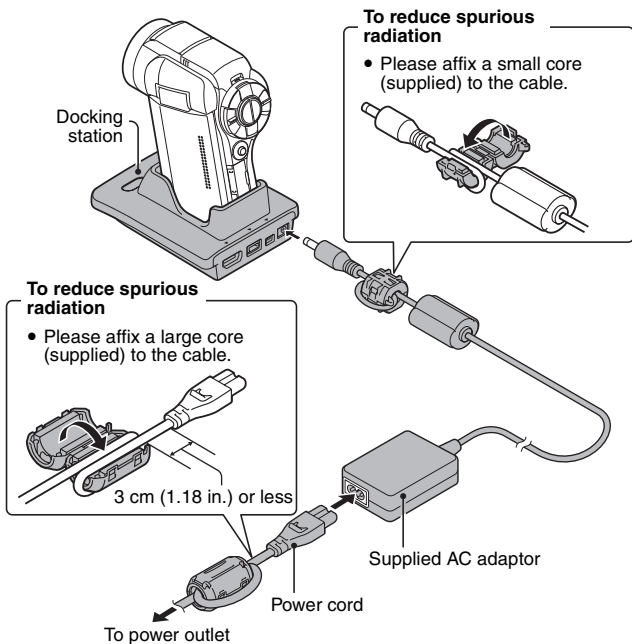

PREPARING THE POWER

About recharging

Recharging takes place only when the camera is turned off, or when the power save function or the sleep function has been activated. Recharging does not take place when the camera is in the shooting mode or playback mode.

TURNING THE CAMERA ON AND OFF

Turning on the camera

1 Set the REC/PLAY switch.

To shoot pictures:

Set to REC.

To play back images:

Set to PLAY.

2 Open the monitor unit.

3 Press the ON/OFF button for at least 1 second.

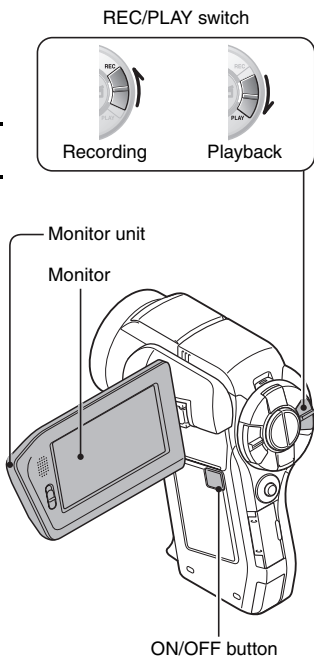

- The camera turns on.
- If the date and time have not been set, the screen to set the date and time is shown on the monitor.



TURNING THE CAMERA ON AND OFF

Turning on the camera when the power save (sleep) mode is active

In order to preserve battery pack power, the power save (sleep) function will automatically turn off the camera after 1 minute of no use during shooting, or 5 minutes of no use during playback (factory-preset setting).

- When the power save mode is active, you can restore the power by any of the following methods:
 - **Move the REC/PLAY switch.**
 - **Press the ON/OFF button.**
 - **Press the [] or [] button.**
 - **Press the SET or MENU button.**
 - **Push the zoom switch.**
 - **Move the SIMPLE/NORMAL switch.**
 - **Press the FULL AUTO button.**
- * When the MENU button is used to turn on the camera, the screen to set the operation sounds (page 144) appears.
- After the power save mode has been active for about 1 hour, the camera will switch to the standby mode. In this case, you can restore the power by pressing the ON/OFF button, or by closing and then opening the monitor unit.
- When the AC adaptor is connected, the power save mode will become active about 10 minutes after the camera is turned on (factory-preset setting).
- The user can specify the time elapsed before the power save mode is activated (page 160).
- When the camera is connected to a computer or printer, the power save mode becomes active after about 12 hours.

Turning off the camera

-
- 1 Press the ON/OFF button for at least 1 second.**
 - The camera turns off.

HINT**To immediately activate the power save mode**

- Press the ON/OFF button briefly to activate the power save function.

About the standby mode

- To turn off the camera only briefly, you can close the monitor unit to put the camera in the standby mode. The standby mode uses almost no power. When the monitor unit is opened again, the camera turns on immediately and you are ready to shoot or view images without any delay.

If the date and time setting has been completed (page 43)

- The current time is shown on the monitor when the REC/PLAY switch is set to REC and the camera is turned on.

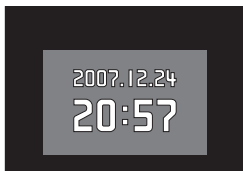

CAUTION**If the  icon appears...**

- When a picture is taken, the date and time it was captured are recorded with it. If the date and time settings have not been completed (page 43), the date and time cannot be recorded with the captured images. For this reason, immediately after the camera is turned on, the “Set date and time” reminder briefly appears, after which the  icon is shown on the Shooting Screen. To have the date and time recorded with the images, please complete this setting before capturing images.

DATE AND TIME SETTING

The camera will record the date and time an image or audio recording is taken so that you can display them during playback. Therefore, before capturing images, make sure the correct date and time are set.

Example: To set the clock to 7:30 p.m. on December 24, 2007

- 1 Turn on the camera (page 40), and press the SET button.**
- The Clock Set Screen appears.
 - The current date and time settings are shown.
 - Follow the procedures below to enable or disable the date display during playback, to set the display format for the date, and to set the date and time.
 - To display the Recording or Playback Screen, press the MENU button 2 times.

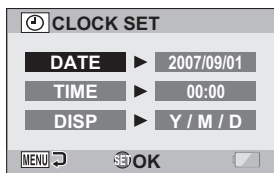

- 2 Set the date.**
- ① Select "DATE".
 - ② Press the SET button.
 - The Set Date Screen appears.
 - ③ Set the date to "2007/12/24".
 - The date is set in the following order: Set the year → Set the month → Set the day.
 - Toggle the SET button left or right to select year, month or day. Toggle the SET button up or down to increase or decrease the number.
 - ④ Press the SET button.

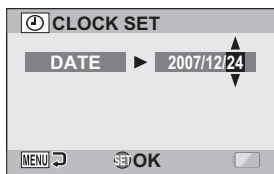

3 Set the clock.

- ① Select "TIME".
- ② Press the SET button.
 - The Set Time Screen appears.
- ③ Set the time to "19:30".
 - The time is set in the following order: Set the hour → Set the minute.
 - A 24-hour clock is used for the time display.
- ④ Press the SET button.

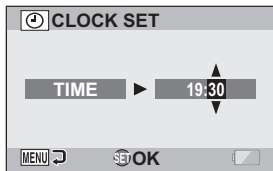

4 Set the order in which the date is displayed during playback.

- ① Select "DISP".
- ② Press the SET button.
 - The Set Date Format Screen appears.
- ③ Toggle the SET button up or down.
 - Toggle the SET button up to change the displayed date order as follows:

→ Y / M / D → M / D / Y → D / M / Y →

Toggle the SET button down to change it in the reverse order.

- ④ Press the SET button.

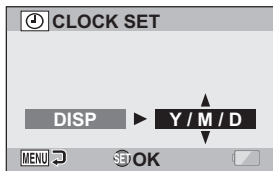

DATE AND TIME SETTING

5 Press the MENU button.

- The date and time setting is completed.
- To display the Recording or Playback Screen, press the MENU button.

HINT

- Under normal conditions, while the battery pack is being replaced, an internal battery will maintain the date and time settings. However, there is a small chance the settings may be lost (the backup will last for about 7 days). It is recommended to check that the date and time settings are still correct after replacing the battery pack and before shooting or recording of any type (follow step 1).

To correct the date and time settings

- After step 1, select the line of the setting that you want to change, press the SET button, and follow the steps in the respective paragraphs above to change the setting.

SWITCHING BETWEEN THE SHOOTING MODE AND PLAYBACK MODE

Switch between the shooting mode (for recording) and the playback mode (for viewing your recorded images).

1 Turn on the camera (page 40).

2 Set the REC/PLAY switch to the desired mode.

For recording:

Set it to REC.

For playback:

Set it to PLAY.

REC/PLAY button

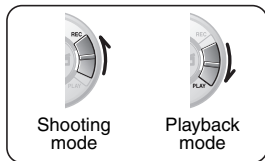

<Example of the shooting mode>



<Example of the playback mode>

SIMPLE MODE/NORMAL MODE

About the SIMPLE mode and NORMAL mode

The “SIMPLE mode” comprises only those functions that are most often used and necessary to operate the camera, while the “NORMAL mode” enables full use of all the camera’s many functions. Select the mode that is suitable for your purposes.

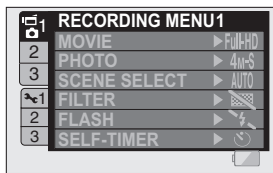

<NORMAL Mode Setting Screen>



<SIMPLE Mode Setting Screen>

Switching between the SIMPLE and NORMAL modes

Use the SIMPLE/NORMAL switch, located next to the monitor, to switch between the SIMPLE and NORMAL modes.

1 Set the SIMPLE/NORMAL switch to the desired mode.

SIMPLE mode:

Set it to SIMPLE.

NORMAL mode:

Set it to NORMAL.

SIMPLE/NORMAL switch

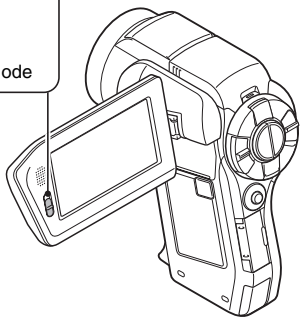
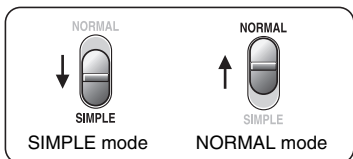

SIMPLE MODE/NORMAL MODE

Accessing/exiting the SIMPLE/NORMAL Mode Menu Screen

- 1** Set the camera to the shooting or playback mode.
- Use the REC/PLAY switch to select the shooting mode or playback mode.

To access the Shooting Menu:

Set the switch to REC.

To access the Playback Menu:

Set the switch to PLAY.

REC/PLAY switch

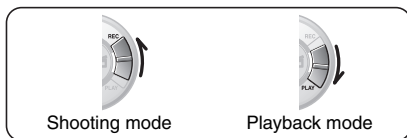

<Shooting mode>



<Playback mode>

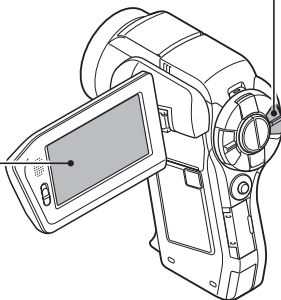

- 2** Set the camera to the **SIMPLE mode** or **NORMAL mode**.
- Use the SIMPLE/NORMAL switch to select the desired mode.

To select the SIMPLE mode:

Set the switch to SIMPLE.

To select the NORMAL mode:

Set the switch to NORMAL.

SIMPLE/NORMAL switch

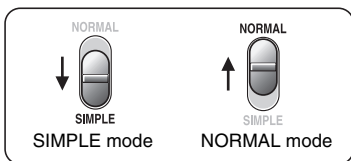

<Example: NORMAL Mode Shooting Screen>

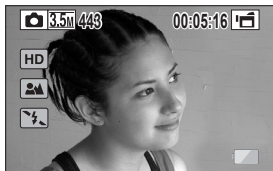

<Example: SIMPLE Mode Shooting Screen>

SIMPLE MODE/NORMAL MODE

3 Press the MENU button.

- The Menu Screen for the mode you selected in steps 1 and 2 appears on the monitor.

Display the SIMPLE Mode Setting Menu → go to page 52, step 4.

Display the NORMAL Mode Setting Menu → go to page 53, step 4.

- To cancel the Menu Screen, press the MENU button.

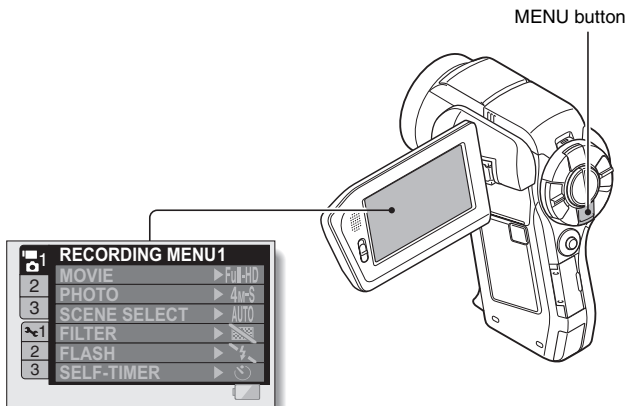

<Example: NORMAL Mode Shooting Menu>



<Example: SIMPLE Mode Shooting Menu>

To access the SIMPLE Mode Setting Menu Screen

- 4** Toggle the SET button up or down to select the item you wish to change, and press the SET button.
- The Setting Screen for the selected item appears.

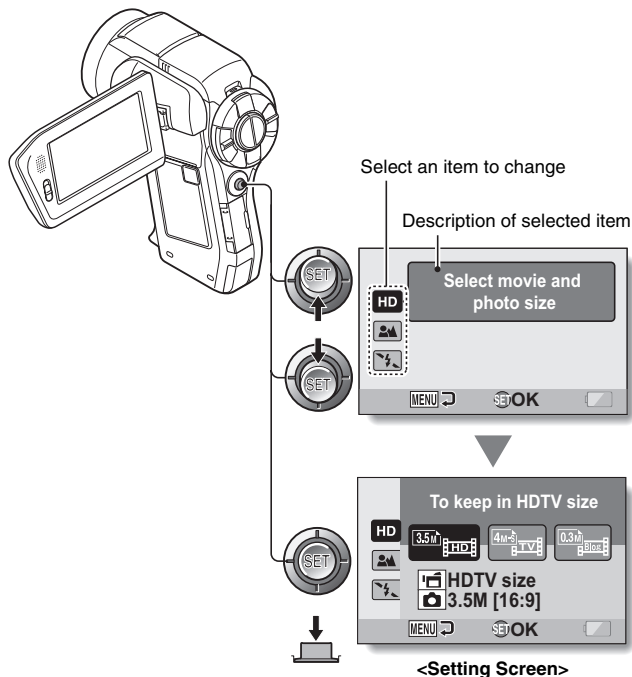

SIMPLE MODE/NORMAL MODE

To access a NORMAL Mode Setting Menu

- 4** Toggle the SET button up or down to select a tab.
- The Menu Screen for the selected tab appears.

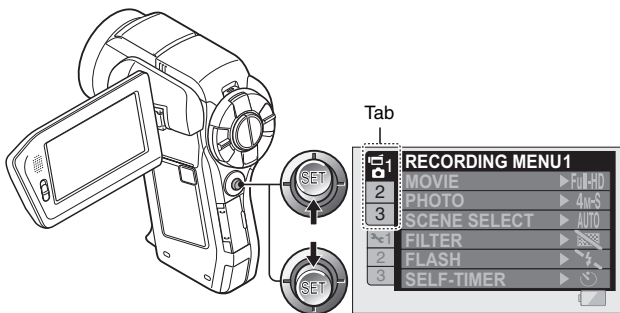

- 5** Toggle the SET button to the right.

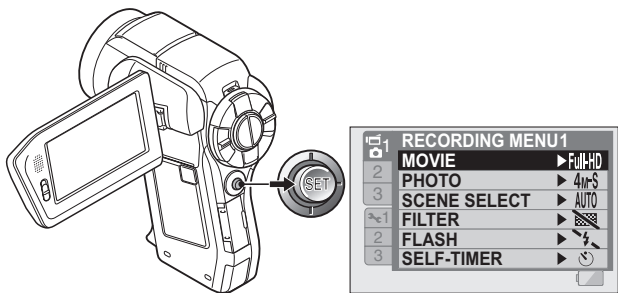

6 Toggle the SET button up or down to select the item you wish to change, and press the SET button.

- The Setting Screen for the selected item appears.
- To return to the Menu Screen, press the MENU button.

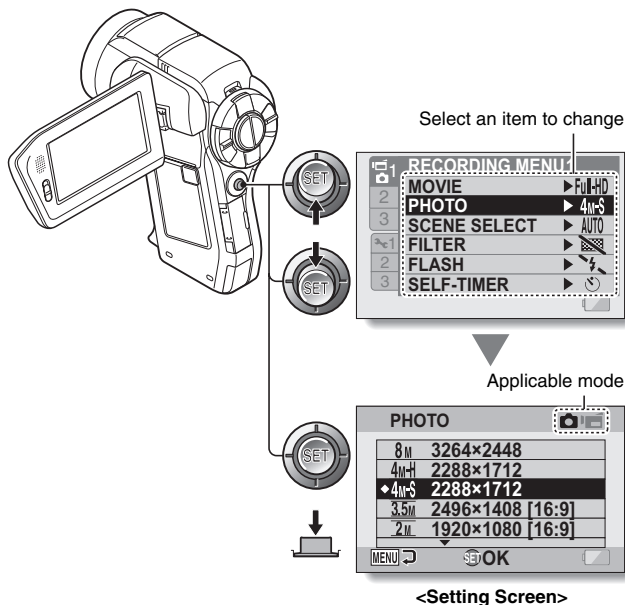

HINT

About the applicable mode indicator

- This indicator shows the shooting mode(s) for which the selected setting is effective.

: This setting is effective during still image shooting.

: This setting is effective during video clip recording.

: This setting is effective during still image shooting and video clip recording.

SIMPLE MODE/NORMAL MODE

Overview of the SIMPLE Mode Setting Screen

SIMPLE Mode Shooting Menu

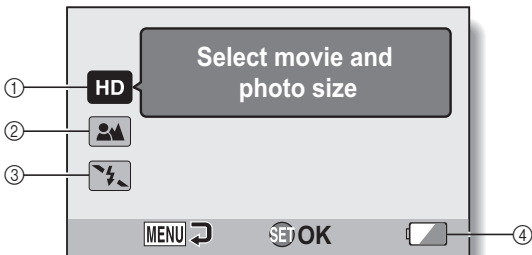

① Recording size (page 71)

- Select the video clip size to record.



- The recorded video clip size will be 1920×1080 pixels, and the captured still image size will be 2496×1408 (16:9) pixels.



- The video clip size will be 640×480 pixels, and the still image size will be 2288×1712 (4:3) pixels.



- The video clip size will be 320×240 pixels, and the still image size will be 640×480 (4:3) pixels.

② Focus range (page 72)

- Select the focus range that corresponds to the distance to the subject.

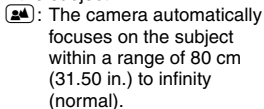

- The camera automatically focuses on the subject within a range of 80 cm (31.50 in.) to infinity (normal).

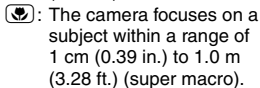

- The camera focuses on a subject within a range of 1 cm (0.39 in.) to 1.0 m (3.28 ft.) (super macro).

③ Flash (page 77)

- Specify how the flash will operate.

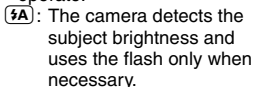

- The camera detects the subject brightness and uses the flash only when necessary.

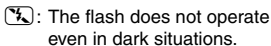

- The flash operates with every image captured regardless of the conditions.

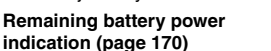

- The flash does not operate even in dark situations.



- The camera detects the subject brightness and uses the flash only when required. At this time the flash operates in a manner that reduces the red reflection ("red-eye") in the subject's eyes.

④ Remaining battery power indication (page 170)

SIMPLE MODE/NORMAL MODE

SIMPLE Mode Playback Menu

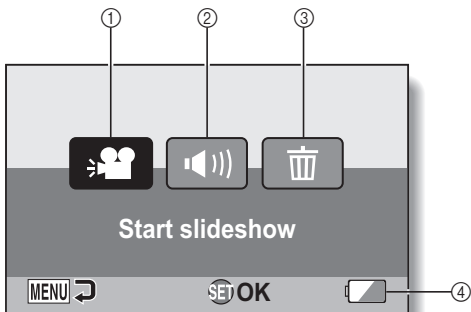

- ① **Slideshow (page 86)**
 - Specify the slideshow settings and play the slideshow.
- ② **Playback volume (page 87)**
 - Adjust the volume for video clip and audio files playback.
- ③ **Delete (page 88)**
 - Delete files.
- ④ **Remaining battery power indication (page 170)**

SIMPLE MODE/NORMAL MODE

Overview of the NORMAL Mode Setting Screen

NORMAL Mode Shooting Menu

<Tab 1>

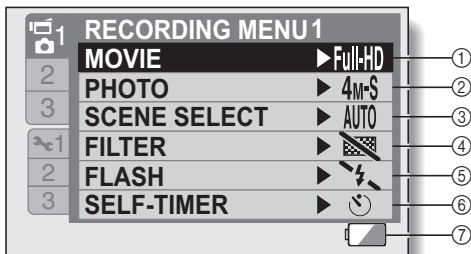

① **Video clip settings (page 93)**

<HD mode>

: Record at 1920 × 1080 pixels, 60 fields/s.

: Record at 1280 × 720 pixels, 60 fps.

: Record at 1280 × 720 pixels, 30 fps.

<SD mode>

: Record at 640 × 480 pixels, 60 fps.

: Record at 640 × 480 pixels, 30 fps

: Record at 320 × 240 pixels, 30 fps.

: Make an audio recording.

② **Still image settings (page 94)**

: Image size is 3264 × 2448 pixels.

: Image size is 2288 × 1712 pixels (low compression).

: Image size is 2288 × 1712 pixels (normal compression).

: Image size is 2496 × 1408 pixels (16:9 aspect ratio).

: Image size is 1920 × 1080 pixels (16:9 aspect ratio).

: Image size is 1600 × 1200 pixels.

: Image size is 1280 × 720 pixels (16:9 aspect ratio).

: Image size is 640 × 480 pixels.

: Image size is 2288 × 1712 pixels.

③ **Scene select (page 99)**

: Full auto setting

: Sports mode

: Portrait mode

: Landscape mode

: Night view portrait mode

: Snow & beach mode

: Fireworks mode

: Lamp mode

④ **Filter (page 101)**

: No filter

: Cosmetic filter

: Monochrome filter

: Sepia filter

⑤ **Flash (page 102)**

: The camera will detect the subject brightness and use the flash only when necessary.



: The flash will operate with every image captured regardless of the conditions.



: The flash will not operate even in dark situations.

: The camera will detect the subject brightness and use the flash only when required. At this time the flash will operate in a manner that reduces the red reflection (“red-eye”) in the subject’s eyes.

⑥ **Self-timer (page 103)**

: Self-timer is off.

: Shooting begins 2 seconds after the [] or [] button is pressed.









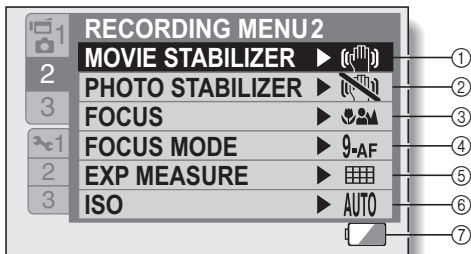

: Shooting begins 10 seconds after the [] or [] button is pressed.

⑦ **Remaining battery power (page 170)**

SIMPLE MODE/NORMAL MODE

<Tab 2>



- ① **Movie stabilizer (page 105)**
- Compensate for camera shake during video clip recording.
 - : Record with image stabilizer on.
 - : Record without image stabilizer.
- ② **Photo stabilizer (page 105)**
- Compensate for camera shake during still image shooting.
 - : Shoot with image stabilizer on.
 - : Shoot without image stabilizer.
- ③ **Focus range (page 107)**
- Select the focus range that corresponds to the distance to the subject.
 - : The camera automatically focuses on the subject within a range of 10 cm (3.94 in.) to infinity (total range).
 - : The camera automatically focuses on the subject with a range of 80 cm (31.5 in.) to infinity (normal).
 - MF**: The focus can be set manually.
 - : The camera focuses on the subject within a range of 1 cm (0.39 in.) to 1.0 m (3.28 ft.) (super macro).
- ④ **Focus area (page 109)**
- 9-AF**: 9-point range finder focus
 - S-AF**: Spot focus
- ⑤ **Light-measuring mode (page 110)**
- : Multi-section light measuring
 - : Center-weighted light measuring
 - : Spot light-measuring
- ⑥ **ISO sensitivity (page 111)**
- AUTO**: Sensitivity is set automatically (video clip recording: ISO 50 to 400; still image shooting: ISO 50 to 200)
- 50**: Sets sensitivity to ISO 50
 - 100**: Sets sensitivity to ISO 100
 - 200**: Sets sensitivity to ISO 200
 - 400**: Sets sensitivity to ISO 400
 - 800**: Sets sensitivity to ISO 800
 - 1600**: Sets sensitivity to ISO 1600 (video clip recording: ISO 800)
 - 3200**: Sets sensitivity to ISO 3200 (video clip recording: ISO 800)
- * The indicated ISO value is the standard output sensitivity.
- ⑦ **Remaining battery power (page 170)**

SIMPLE MODE/NORMAL MODE

<Tab 3>

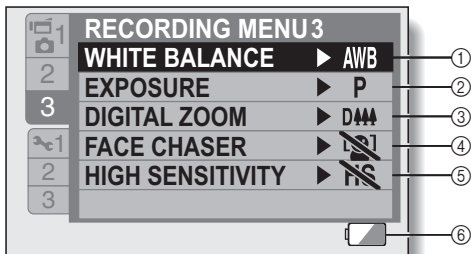



① **White balance (page 113)**

: White balance is automatically adjusted depending on the ambient lighting (auto).

: For shooting in sunny conditions (fair)

: For shooting in overcast conditions (cloudy)

: For shooting under fluorescent lighting (fluorescent)

: For shooting under incandescent lighting (incandescent)

: For setting the most accurate white balance (one push)

② **Exposure (page 114)**

: The exposure is set automatically.

: Set the shutter speed manually.

: Set the aperture manually.

: Set the aperture and shutter speed manually.

③ **Digital zoom (page 116)**

: Enable the digital zoom.

: Disable the digital zoom.

④ **Face chaser (page 117)**

: Enable face chaser.

: Disable face chaser.

⑤ **High sensitivity mode (page 118)**

: Increased sensitivity

: Normal sensitivity

⑥ **Remaining battery power indication (page 170)**

SIMPLE MODE/NORMAL MODE

NORMAL Mode Playback Menu

<Tab 1>

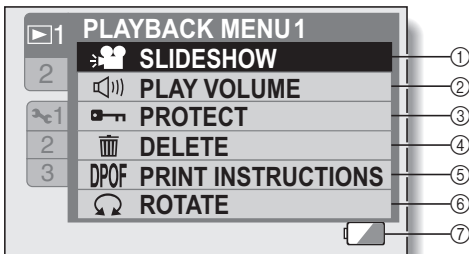

- ① **Slideshow (page 120)**
 - Specify the slideshow settings and play the slideshow.
- ② **Playback volume (page 87)**
 - Adjust the volume for video clip and audio files playback.
- ③ **Protect (page 122)**
 - File protect setting (delete prohibited)
- ④ **Delete (page 88)**
 - Delete files.
- ⑤ **Printing instructions (page 123)**
 - Specify the printing instructions (DPOF settings).
- ⑥ **Rotate (page 129)**
 - Rotate a still image.
- ⑦ **Remaining battery power (page 170)**

<Tab 2>

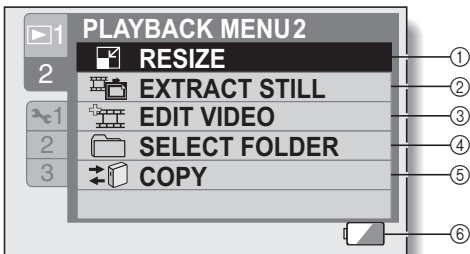

- ① **Resize (page 130)**
 - Reduce the resolution of a still image.
- ② **Extract still image (page 131)**
 - Extract a still image from a video clip.
- ③ **Video clip edit (page 132)**
 - Edit video clips.
- ④ **Select folder (page 91)**
 - Select a folder to play back.
- ⑤ **Copy**
 - Used for the Xacti Library feature.
- ⑥ **Remaining battery power indication (page 170)**

FULL AUTO MODE

In the full auto mode, you can record files using the settings in effect at the time of shipment from the factory. However, even if you set the camera to the full auto mode, the settings you specified in the SIMPLE mode and NORMAL mode are retained, so your specified settings will be restored when you quit the full auto mode.

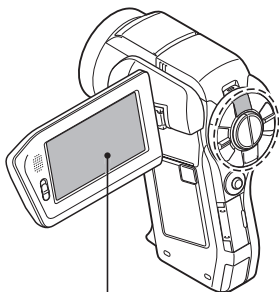

Normal mode

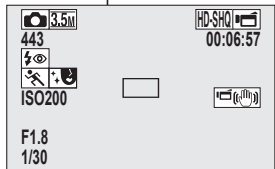

FULL AUTO button

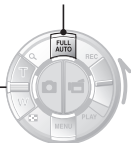

- Inoperative during playback.
- If you change the shooting settings or option settings when in the full auto mode, the camera changes to the NORMAL mode.

Press



Full auto Mode

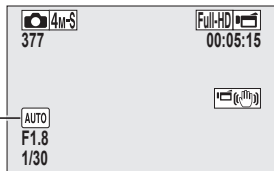

The full auto icon is shown.

FULL
AUTO

Press

BEFORE TAKING PICTURES

For best results

Hold the camera securely, keeping your elbows close to your body and making sure the camera is stable.

Correct hold



Incorrect hold



<Holding the camera>

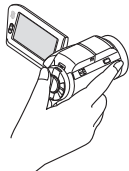

Example 1:
Grip the camera by wrapping the fingers of the right hand, from the little finger to the middle finger, around the camera, and hook the index finger above the lens.

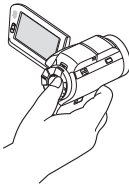

Example 2:
Grip the camera by wrapping the fingers of the right hand, from the little finger to the index finger, around the camera.

A finger is blocking the lens or flash.

Make sure that the lens and flash are not blocked by your fingers or the handstrap.

BEFORE TAKING PICTURES

Using the autofocus

The autofocus will work in almost all situations; however, there are certain conditions that may cause the autofocus function to not work properly. If the autofocus function is not working properly, set the focus range to capture images (page 72).

■ Conditions that may cause incorrect focus

The following examples are some of the situations where the autofocus function may not work.

- **Subjects with low contrast, very bright subjects at the center of the image or dark subjects or locations**
Use the focus-lock function to lock the focus on an object with contrast at the same distance as the desired subject.

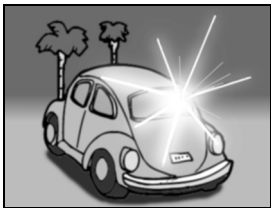

- **Subjects without vertical lines**
Use the focus-lock function to lock the focus while framing the subject vertically, then re-orient the camera to compose a horizontally framed image.

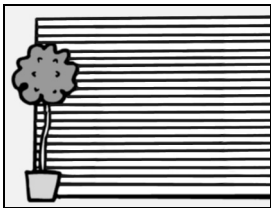

The following examples are some of the situations where the autofocus function may work, but not as desired.

- **When both near and far objects are present**

Use the focus-lock function to lock the focus on an object at the same distance as the desired subject, then reposition the camera to compose the picture.



- **Fast-moving subjects**

Use the focus-lock function to lock the focus on an object at the same distance as the desired subject, then reposition the camera to compose the picture.

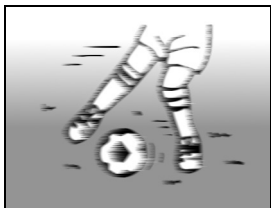

HINT

- Images captured in the still image shooting mode can be rotated when they are played back (page 129).
- When the [] button is pressed halfway, the image in the monitor may waver vertically. This is the result of internal image processing and is not a malfunction. This wavering is not recorded and will not affect your images in any way.
- When the optical zoom is used or when the autofocus is operating, the image may appear to waver, but this is not a malfunction.

BEFORE TAKING PICTURES

Select the recording size

The larger the image size (number of pixels), the better the image quality will be, but the file size will also be larger. Select the image quality that is correct for the intended purpose.

- 1 Display the **SIMPLE Mode Shooting Menu** (page 49), select the recording size setting, and press the **SET** button.

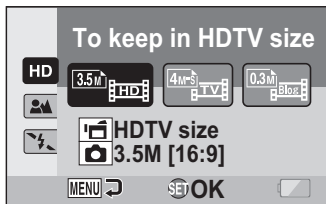

- : The recorded video clip size will be 1920 × 1080 pixels, and the captured still image size will be 2496 × 1408 (16:9) pixels.
- : The video clip size will be 640 × 480 pixels, and the still image size will be 2288 × 1712 (4:3) pixels.
- : The video clip size will be 320 × 240 pixels, and the still image size will be 640 × 480 (4:3) pixels.

- 2 Select the desired video clip recording size, and press the **SET** button.



- This completes the recording size setting.

Select the focus setting

Select the focus range corresponding to the distance between the camera and the subject.

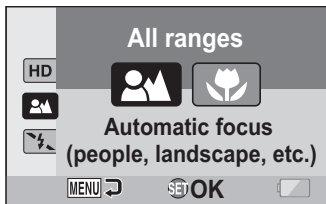
- 1 Display the **SIMPLE Mode Shooting Menu** (page 49), select the focus setting, and press the **SET** button.



- : The camera automatically focuses on the subject within a range of 80 cm (31.50 in.) to infinity (normal).
- : The camera focuses on a subject within a range of 1 cm (0.39 in.) to 1.0 m (3.28 ft.) (super macro).

- 2 Select the desired focus range, and press the **SET** button.
 - This completes the focus range setting.

BEFORE TAKING PICTURES

Hints for taking pictures

Muting the operation sounds

- The operation sounds that are generated, for example, when the [] button, MENU button or SET button is pressed, as well as the audio guidance when you switch the mode, can be muted (page 144).

Where are the image and audio files saved?

- All the image and sound files are recorded on the card installed in the camera.

Taking pictures in backlight conditions...

- When taking pictures with the light coming from behind the subject, due to the characteristics of the lens, ghost patterns (flare phenomenon) may appear in the captured image. In this situation, it is recommended that you avoid taking pictures with the subject lit from behind.

While the image files are being recorded...



- While the multi-indicator is flashing red, the image files are being written to the memory, during which time it is not possible to capture another image. Another image can be captured after the flashing red indicator turns off. However, even when the multi-indicator is flashing red, depending on the camera's internal memory remaining capacity, in some cases the next image can be captured about 2 seconds after shooting.

Checking the last image shot (instant review)

- After shooting a picture, you can immediately view it by pressing the SET button once.
- During instant review of a video clip, normal play, reverse play and pause are available (page 84).
- If you wish to delete the image (for a video clip, it must be in the pause or stop mode), toggle the SET button up to access the delete function.
- You can view other images while the instant review display is showing by toggling the SET button to the left or right.
- Cancel the instant review display by toggling the SET button down.

VIDEO CLIP RECORDING

- 1 Turn on the camera (page 40), and set it to the shooting mode (page 46).

- 2 Press the [] button.
 - Recording begins.
 - It is not necessary to keep the [] button pressed while shooting.
 - When the remaining recording time available for the currently recording clip becomes little, a countdown of the remaining recording time appears on the display.



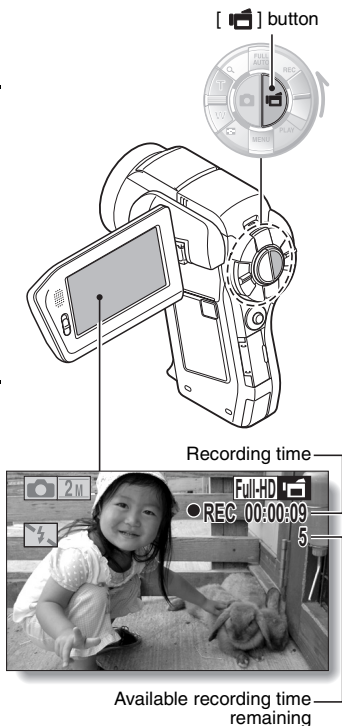

- 3 End the recording.
 - Press the [] button again to stop recording.



SHOOTING SINGLE SHOTS

Capture a still image (single-shot).

- 1 Turn on the camera (page 40), and set it to the shooting mode (page 46).

- 2 Press the [] button.
 - ① Press the [] button halfway.
 - The autofocus operates, and the image is focused (focus lock).
 - ② Continue to gently press the [] button all the way.
 - The shutter releases and the image is captured.
 - You can view the captured image on the monitor by keeping the [] button depressed when you capture the image (post-view [page 146]).

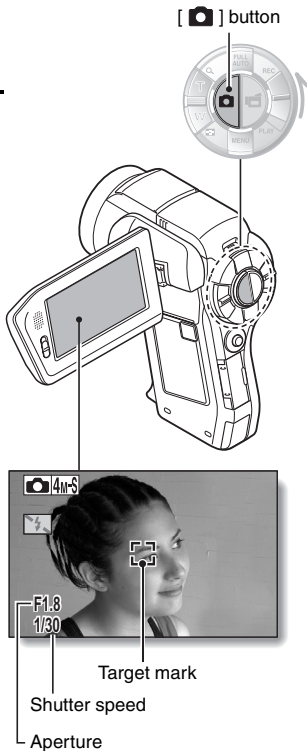
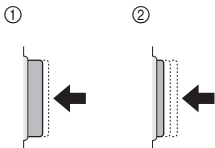



HINT**Adjusting the monitor brightness**

- While the Shooting Screen is active, you can quickly access the screen for adjusting the brightness of the monitor (page 153) by pressing the MENU button for at least 1 second.

What is the camera focusing on?

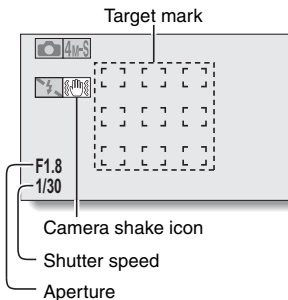
- A target mark  on the monitor shows the area the camera is focusing on.
- The camera automatically determines the correct focus by measuring from 9 different focus points within the shooting area. If the target mark is at a position that is different from the point you wish to focus on, you can refocus, for example, by changing the shooting angle.
- The large target mark appears when the camera focuses on a wide area in the center of the screen.

**The focus can be locked**

- By assigning an operation shortcut to the SET button (page 148), the autofocus can be set to a fixed focus. When the autofocus is fixed, the  icon appears on the monitor.
- When the focus range (page 72) setting is changed, the focus lock is released.

The shutter speed and aperture are displayed

- The shutter speed and aperture settings are shown on the Shooting Screen. You can use them as a reference when shooting.

If the camera shake icon  appears...

- During still image shooting, if the shutter speed is slow and the possibility that the image may be blurred due to camera shake becomes high, the camera shake icon may appear on the monitor. In this case, use a tripod to stabilize the camera when shooting, or set the flash operation mode to automatic (page 77).
- When shooting with the scene select function set to the fireworks  mode, the camera shake icon always appears, but this is normal.

SHOOTING SINGLE SHOTS

Using the flash

The flash is not only used for photographing under dark conditions, but is also convenient for example when the subject is in shadow or lit from behind. Your camera is equipped with four flash modes: red-eye reduction, auto flash, forced flash, and no flash. Select the flash mode that is suitable for the shooting conditions. The flash is available only when shooting single-shot still images.

- 1 Press the  button to open the flash unit.





- The flash unit opens.

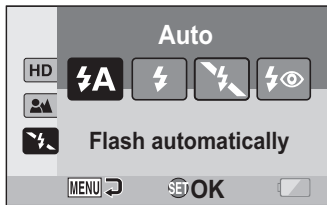

- 2 Display the SIMPLE Mode Shooting Menu (page 49), select the flash setting, and press the SET button.

- The screen to select the flash operation appears.



- : The camera detects the subject brightness and uses the flash only when necessary.
- : The flash operates with every image captured regardless of the conditions.
- : The flash does not operate even in dark situations.
- : The camera detects the subject brightness and uses the flash only when required. At this time the flash operates in a manner that reduces the red reflection (“red-eye”) in the subject’s eyes.

-
- 3** Select the desired flash operation, and press the SET button.
- This completes the flash operation setting.

-
- 4** Press the [] button to take the picture.
-

CAUTION

Do not touch the flash unit when shooting



- The flash unit becomes very hot and may cause a burn. Avoid touching the flash unit when shooting.

HINT

- The flash cannot be used during video clip recording.
- By assigning an operation shortcut to the SET button (page 148), you can change the flash mode from the Shooting Screen (in the NORMAL mode).

SHOOT A STILL IMAGE WHILE RECORDING A VIDEO CLIP

You can capture a still image (a single-shot) while recording a video clip.

- 1** Turn on the camera (page 40), and set it to the shooting mode (page 46).
 - 2** Press the [] button.
 - 3** When you see a scene you'd like to capture as a still image, press the [] button.
 - 4** Press the [] button to end the video clip recording.
-

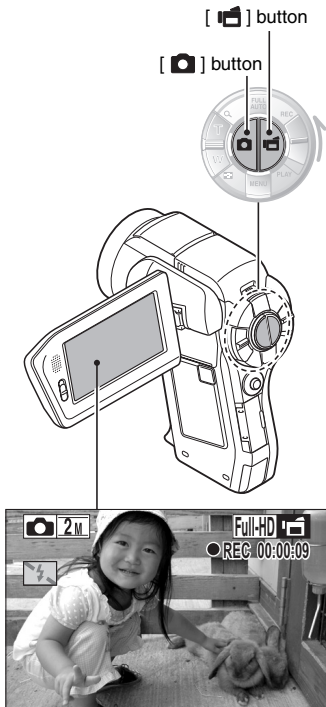

HINT

- When shooting a still image while recording a video clip, the flash does not operate.
- The photo stabilizer (page 105) and the face chaser feature (page 117) are inoperative.
- When the remaining video recording time becomes approximately 50 seconds, it will no longer be possible to capture a still image while recording a video clip. The exact remaining recording time at which this occurs will differ depending on the subject and on the video clip mode setting (page 93). If you intend to capture a still image while recording a video clip, it is suggested that you take note of the remaining video recording time.

About the recording size of still images

- The size of a still image captured during video clip recording depends on the video clip recording size.

Video clip recording size setting	Still image recording size
Full-HD	2M (16:9)
HD-HR HD-SHQ	0.9M (16:9)
TV-HR TV-SHQ 66SHQ	0.3M (4:3)

MACRO-PHOTOGRAPHY (ZOOM)

Your camera has two zoom functions: optical zoom and digital zoom.

1 Point the camera lens at the subject.

2 Push the zoom switch toward [T/🔍] or [W/📐] to compose the desired image.

[T/🔍]: Zoom in on the subject.

[W/📐]: Zoom out.

- When the zoom switch is pushed, the zoom bar appears on the monitor.
- When moving the optical zoom, push the zoom switch lightly to zoom slowly, and press more strongly to zoom quickly.
- When the optical zoom factor is at maximum, zooming stops temporarily. When the zoom switch is pushed toward the [T/🔍] side again, the mode changes to the digital zoom mode and zooming continues.

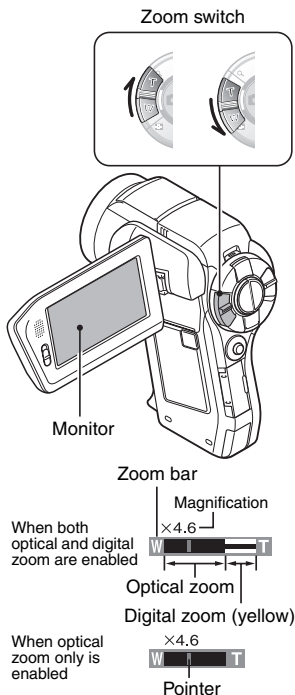

3 Take the picture.

For video clip recording, see page 74.

For shooting single shots, see page 75.

For shooting sequential shots, see page 95.

SHOOTING AND PLAYBACK WITH THE REMOTE CONTROL UNIT

The remote control sensor on your camera makes it possible to capture images and play them back using the supplied remote control unit.

- 1 Prepare the remote control unit (page 30).**
 - 2 Turn the camera on, and set the REC/PLAY switch to REC or PLAY.**
 - Set the REC/PLAY switch to REC for shooting, or to PLAY for playback.
 - 3 Aim the remote control unit at the camera's remote control sensor.**
 - Open the monitor unit.
 - 4 Press the buttons on the remote control unit to operate the camera (page 26).**
-

PLAYING BACK VIDEO CLIPS AND STILL IMAGES

1 Set the camera to the playback mode (page 46).

2 Toggle the SET button to the left or right to display the image you wish to play back.

- Video clips are indicated by a video clip pattern along the left and right sides of the screen.



<Example: After recording a video clip>

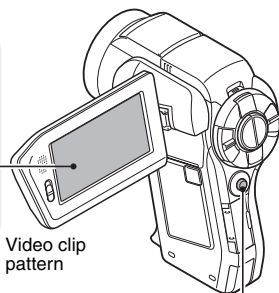

SET button



<Example: After capturing a still image>

3 For a video clip, press the SET button.

- Playback begins.

To do this...		Do this
Normal forward playback		Press the SET button.
Stop playback		During playback, toggle the SET button down.
Pause		During playback, press the SET button or toggle the SET button up. During accelerated playback, toggle the SET button up.
To play back one image at a time (single-frame step)	During forward playback	After pausing playback, toggle the SET button to the right.
	During reverse playback	After pausing playback, toggle the SET button to the left.
Slow playback	During forward playback	After pausing playback, press and hold the SET button to the right.
	During reverse playback	After pausing playback, press and hold the SET button to the left.
To accelerate playback	Forward playback	During forward playback, toggle the SET button to the right. * The playback speed changes each time the SET button is toggled to the right, as follows: Normal playback → 2× → 5× → 10× → 15× Toggle the SET button to the left to resume normal playback speed.
	Reverse playback	During forward playback, toggle the SET button to the left. * The playback speed changes each time the SET button is toggled to the left, as follows: 15× ← 10× ← 5× Toggle the SET button to the right to resume normal playback speed.
Return to normal playback speed		Press the SET button.
Adjusting the volume		Louder: During playback, push the zoom switch toward the [T] side. Softer: During playback, push the zoom switch toward the [W] side.

When you are finished using the camera...

- Press the ON/OFF button to turn the camera off.

PLAYING BACK VIDEO CLIPS AND STILL IMAGES

HINT

The file for a video clip is very large

- Therefore, be aware that if the video clip is uploaded to a computer to be played back, the computer may not be able to play back the video fast enough, making it appear jerky. (The video will always be displayed properly on the monitor or a television.)
- Depending on the card, shooting may end even before the possible shooting time indicated.

Display the video clip playback point

- During video clip playback, press the MENU button for at least 1 second to display a bar showing the current playback point in the video clip.
- Press the MENU button for about 1 second to cancel the bar.

CAUTION

During video clip playback, the sound of a motor is audible...

- During recording, the sound of the optical zoom movement or autofocus movement was recorded. This is not a malfunction.



If no audio is heard...

- The audio is not played back when the video clip is played back in the frame-by-frame, fast playback or reverse playback mode.

SLIDESHOW PLAYBACK

You can play back files in succession with the “slideshow playback” feature.

- 1** Display the **SIMPLE Mode Playback Menu (page 49)**, select the slideshow setting, and press the **SET** button.

- : Play back all files.
- : Play back video clips and audio files.
- : Play back still image files.

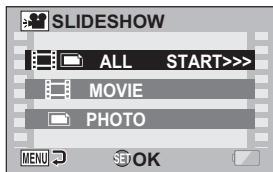

- 2** Select the type of file to play back, and press the **SET** button.
 - Slideshow playback begins.
 - To stop slideshow playback, press the **SET** button or **MENU** button.

HINT

About the slideshow settings

- During slideshow playback, the BGM that was set for the slideshow from the **NORMAL Mode Playback Menu** is played. To change the BGM, display the **NORMAL Mode Playback Menu** and change the BGM setting for the **SLIDESHOW** (page 120).
- For slideshows played in the **SIMPLE** mode, the transition effect is fixed at **FADE** and the transition interval is fixed at **2 SEC.**

PLAYBACK VOLUME

Adjust the playback volume for video clips and audio files.

- 1** Display the **SIMPLE Mode Playback Menu** (page 49), select the playback volume setting, and press the **SET** button.
 - The volume control bar appears.

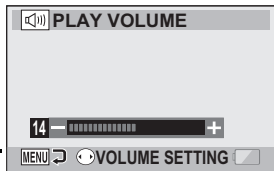

- 2** Toggle the **SET** button to the left or right to set the volume, and press the **SET** button.
 - The playback volume is set, and the display returns to the **SIMPLE Mode Playback Menu**.

HINT

The volume can be adjusted during playback

- During video clip or audio file playback, if you move the zoom switch, the volume control bar will appear, allowing you to adjust the volume.

In the **NORMAL** mode

- When you select "PLAY VOLUME" from the **NORMAL Mode Playback Menu** and press the **SET** button, the volume control bar appears.

DELETING FILES

You can delete files if you no longer need them. You can delete the files one at a time, or all at once.

- 1** Display the **SIMPLE Mode Playback Menu** (page 49), select the delete  icon, and press the **SET** button.

DELETE SINGLE:

Deletes one file at a time.

DELETE ALL:

Deletes all files.

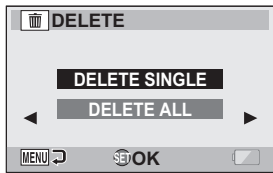

- 2** Select the desired delete mode, and press the **SET** button.

- The Delete Confirmation Screen appears.

<DELETE SINGLE>

- Toggle the SET button to the left or right to select the file you wish to delete.
- There is no confirmation screen when deleting single files. Please make sure that the displayed image is one you wish to delete.

<DELETE ALL>

- Toggle the SET button to the left or right to confirm the files to delete.

DELETING FILES

3 Select “DELETE”, and press the SET button.

<DELETE SINGLE>

- The currently displayed file is deleted.
- To delete other files, select the files, select “DELETE” and press the SET button.

<DELETE ALL>

- The Delete Confirmation Screen again appears. To delete the files, select “YES”, and press the SET button. When file delete is completed, “No image” is shown.

HINT

In the NORMAL mode

- When you select “DELETE” from the NORMAL Mode Playback Menu and press the SET button, the Delete Screen appears.

CAUTION

- Files that are protected from accidental delete cannot be deleted. To delete protected files, set the protect setting for the files to off (page 122), and then follow the file delete procedure.

PLAYBACK MODES

9-image display playback

1 Display the image you wish to play back.

2 Push the zoom switch toward the [W/📷] side.

- The 9-image display appears.

3 Select the image to play back.

- Toggle the SET button up, down, left or right to move the orange frame to the desired image, and press the SET button.

Instead of pressing the SET button, you can push the zoom switch toward the [T/🔍] side to show the image full screen.

- If the zoom switch is pushed toward the [W/📷] side while the 9-image display is shown, the display changes to the screen to select the playback folder (page 91).

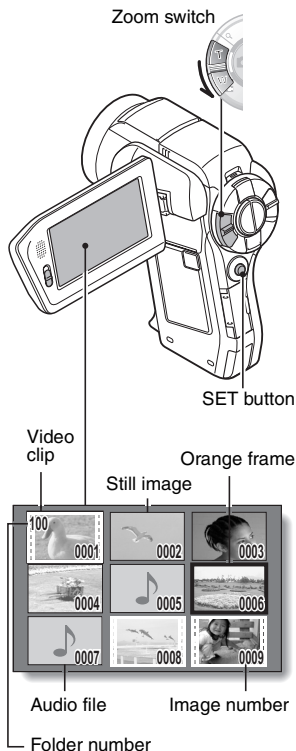

PLAYBACK MODES

Selecting the playback folder

If the card contains multiple folders, you can select from which folder you would like to play back.

1 Display the Playback Screen.

2 Push the zoom switch toward the [W/☐] side 2 times.

- The screen to select the playback folder appears.
- If the zoom switch is pushed toward the [T/🔍] side, the camera changes to the 9-image display (page 90).

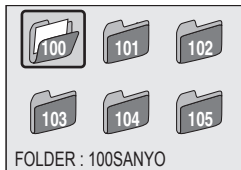

3 Toggle the SET button to the left or right to move the orange frame to the desired folder, and press the SET button.

- The files in the selected folder are displayed in the Playback Screen.

HINT

In the NORMAL mode

- When you select “SELECT FOLDER” from the NORMAL Mode Playback Menu and press the SET button, the screen to select the playback folder appears.

Magnifying (zooming in) the image

- 1 Display the image that you want to magnify.**
 - For a video clip, pause playback at the place you want to magnify.

- 2 Push the zoom switch toward the [T/🔍] side.**

- Magnification is enabled.
- The image is magnified, and the central portion of image is displayed.
- Toggle the SET button to view different parts of the magnified image.

To magnify:

Magnification increases each time the zoom switch is pushed toward the [T/🔍] side.

To return to normal size:

Magnification decreases each time the zoom switch is pushed toward the [W/🔍] side.

- Press the SET button to return to the normal (100%) view.



HINT

The magnified portion of the image can be saved as a separate image

- Press the [📷] button. The magnified portion is saved as a new still image.

RECORDING SIZE

The image quality of video clips and still images is determined by the recording size (number of pixels). The larger the recording size, the better the image quality will be, but the file size will also be larger. Select the recording size that is correct for the intended purpose.

Movies

You can record video clips in either the HD mode (16:9 horizontal to vertical aspect ratio) or the SD mode (4:3 aspect ratio). In addition, the higher the frame rate number, the smoother playback will be. However, as with the recording size, the file size is also proportionately larger, using up more memory. This menu is also used when making audio recordings.

1 Display the **NORMAL Mode Shooting Menu** (page 49), select **"MOVIE"**, and press the **SET** button.

<HD mode>

: Record video clips at 1920 × 1080 pixels, 60 fields/s.

: Record video clips at 1280 × 720 pixels, 60 fps.

: Record video clips at 1280 × 720 pixels, 30 fps.

<SD mode>

: Record video clips at 640 × 480 pixels, 60 fps.

: Record video clips at 640 × 480 pixels, 30 fps.

: Record video clips at 320 × 240 pixels, 30 fps.

<Audio mode>

: Make an audio recording (voice memo).

2 Select the desired recording size, and press the **SET** button.

- This completes the recording size setting.

CAUTION

When editing video clips...

- In order for video clips to be joined, they must have been photographed in the same mode.
- Video clips that were photographed in different modes cannot be joined.

Still images

For still images, you can select either the 4:3 or 16:9 horizontal to vertical aspect ratio. This menu is also used for shooting sequential shots.

1 Display the NORMAL Mode Shooting Menu (page 49), select “PHOTO”, and press the SET button.

: Image size is 3264 × 2448 pixels.

: Image size is 2288 × 1712 pixels (low compression).

: Image size is 2288 × 1712 pixels (normal compression).

: Image size is 2496 × 1408 pixels (16:9 ratio).

: Image size is 1920 × 1080 pixels (16:9 ratio).

: Image size is 1600 × 1200 pixels.

: Image size is 1280 × 720 pixels (16:9 ratio).

: Image size is 640 × 480 pixels.



: Image size is 2288 × 1712 pixels.

2 Select the desired recording size, and press the SET button.

- This completes the recording size setting.

RECORDING SIZE

Sequential shots

- 1 Display the **NORMAL Mode Shooting Menu** (page 49), select “PHOTO”, and press the **SET** button.
 - 2 Select , and press the **SET** button.
 - 3 Press the [] button.
 - Shooting begins. Shooting continues as long as the [] button is kept pressed.
-

HINT

- The maximum number of images in a sequential shots sequence is 7.
- About the focus when shooting sequential shots**
- When sequential shots are captured, the autofocus operates when the [] button is pressed halfway, fixing the focus.
- Can the flash be used?**
- The flash does not operate when shooting sequential shots.

Audio recording

Your camera can make audio recordings and play them back.

Audio recording

- 1 Display the **NORMAL Mode Shooting Menu** (page 49), select “**MOVIE**”, and press the **SET** button.

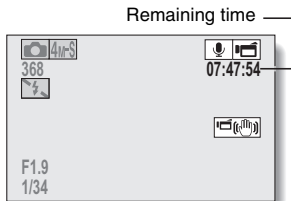

- 2 Select , and press the **SET** button.

- The audio recording mode is enabled.
- The menu display is canceled if the **MENU** button is pressed.



RECORDING SIZE

3 Press the [] button.

- Audio recording begins. During recording,  appears in the monitor. It is not necessary to continue pressing the [] button while recording.
- The maximum time for recording a continuous audio memo is about 13 hours.

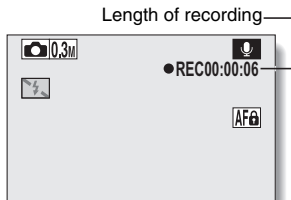



4 End the recording.

- Press the [] button again to stop recording.

HINT

You can capture a still image during an audio recording

- Press the [] button during audio recording to capture a  still image.

Audio playback

1 Display the desired audio file.

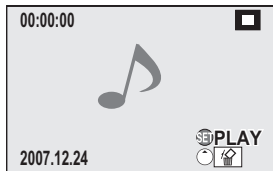

2 Play back the recording.

To do this...		Do this
Normal playback	Start playback	Press the SET button.
	Pause	Press the SET button. Toggle the SET button up.
	Stop playback	Toggle the SET button down.
Fast forward/ fast reverse	Fast forward	During playback, toggle the SET button to the right. Each time the SET button is toggled to the right, the speed increases. If the SET button is toggled to the left during fast forward, the speed decreases.
	Fast reverse	During playback, toggle the SET button to the left. Each time the SET button is toggled to the left, the speed increases. If the SET button is toggled to the right during fast reverse, the speed decreases.
	Pause	Toggle the SET button up.
	Return to normal playback	Press the SET button.
Volume adjustment	Louder	During playback, push the zoom switch toward the [T/🔍] side.
	Softer	During playback, push the zoom switch toward the [W/📺] side.

CAUTION









If no audio is heard...

- The audio is not played back when the audio recording is played back in the fast playback or fast reverse mode.

SCENE SELECT

You can select from various preset settings (aperture, shutter speed, etc.) for specific shooting conditions.

- 1 Display the **NORMAL Mode Shooting Menu** (page 49), select **"SCENE SELECT"**, and press the **SET** button.



Scene setting	Features	Shooting mode setting		
		Single-shot	Sequential shots	Video clip
 Auto	The camera makes the optimum settings.	<input type="radio"/>	<input type="radio"/>	<input type="radio"/>
 Sports	Capture a split-second image of a fast-moving subject.	<input type="radio"/>	<input type="radio"/>	<input type="radio"/>
 Portrait	Enhance the three-dimensional feel of the subject by blurring the background.	<input type="radio"/>	<input type="radio"/>	<input type="radio"/>
 Landscape	For beautiful shots of distant scenery.	<input type="radio"/>	<input type="radio"/>	<input type="radio"/>
 Night view portrait	Photograph the subject while keeping the background night scenery.	<input type="radio"/>	<input checked="" type="checkbox"/>	<input type="radio"/>
 Snow & beach	For photographing bright scenes, such as on a ski slope or at the beach.	<input type="radio"/>	<input type="radio"/>	<input type="radio"/>
 Fireworks	For capturing fireworks at night.	<input type="radio"/>	<input checked="" type="checkbox"/>	<input type="radio"/>
 Lamp	Photograph in low-light conditions	<input type="radio"/>	<input checked="" type="checkbox"/>	<input type="radio"/>

: Available : Not available

2 Select the desired icon, and press the SET button.

- This completes the scene select function setting.
- To return to normal photography, select **AUTO** from the scene select menu, and press the SET button.

HINT

- When capturing images using the lamp , fireworks  or night view portrait  setting, use a tripod or other method to stabilize the camera.
- A table showing the limitations for settings corresponding to scene select icons other than **AUTO** is on page 208.

FILTERS

The filter feature changes image characteristics such as color tones, to apply unique effects to the photographed image.

1 Display the NORMAL Mode Shooting Menu (page 49), select “FILTER”, and press the SET button.

: No filter is used (none).

: Skin tones are enhanced in close-up shots (cosmetic filter).

: Snap black-and-white photos (monochrome filter).

: Create a sepia-tone photo (sepia filter).

2 Select the desired icon, and press the SET button.

- This completes the filter setting.
 - To return to normal photography, select  from the filter menu, and press the SET button.
-

HINT

- A table showing the limitations for settings corresponding to filter icons other than  is on page 209.





FLASH OPERATION

- 1** Press the  button to open the flash unit.

- The flash unit opens.



- 2** Display the **NORMAL Mode Shooting Menu** (page 49), select **“FLASH”**, and press the **SET** button.

- : The camera detects the subject brightness and uses the flash only when necessary.
- : The flash operates with every image captured, regardless of the subject brightness.
- : The flash does not operate even in dark surroundings.
- : The camera detects the subject brightness, and if it determines that the flash is necessary, a pre-flash is emitted, after which the actual flash is emitted as the image is captured. This has the effect of minimizing the red reflection (“red-eye”) in the subject’s eyes.

- 3** Select the desired flash operation, and press the **SET** button.

- This completes the flash operation setting.

- 4** Press the [] button to capture the image.



HINT



- The flash works only when shooting single-shot still images.

SELF-TIMER

1 Display the NORMAL Mode Shooting Menu (page 49), select “SELF-TIMER”, and press the SET button.

: Turns off the self-timer function.

: The image is captured about 2 seconds after the [] button or [] button is pressed.

: The image is captured about 10 seconds after the [] button or [] button is pressed.

2 Select the desired icon, and press the SET button.







- This completes the self-timer setting.

3 Take the picture.



HINT

- By assigning an operation shortcut to the SET button (page 148), you can set the self-timer from the Shooting Screen.

To pause or cancel the self-timer function...

- If the [] button or [] button is pressed again before the shutter is released, the self-timer countdown temporarily stops. Press the [] button or [] button one more time to restart the self-timer.
- To cancel self-timer photography, select the  icon from the self-timer menu, and press the SET button.
- The self-timer is automatically reset to off  after the power save mode is activated and the camera turned off.

When is selected...

- When the [] button or [] button is pressed, the multi-indicator will blink for about 10 seconds, and then the image is captured. Also, 4 seconds before the shutter releases, the indication shown in the illustration appears on the monitor.

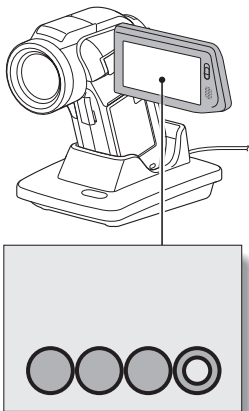

If you swivel the monitor unit to its farthest position, the image on the monitor will be inverted.

MOTION COMPENSATION (IMAGE STABILIZER)

Your camera can minimize a jittery picture by compensating for unintentional hand motion.

Compensate for camera shake when recording movies

- 1 Display the **NORMAL Mode Shooting Menu** (page 49), select **“MOVIE STABILIZER”**, and press the **SET** button.

: Motion compensation is enabled.

: Motion compensation is not enabled.

- 2 Select the desired setting, and press the **SET** button.
 - This completes the movie stabilizer setting.

Compensate for camera shake when shooting still images

- 1 Display the **NORMAL Mode Shooting Menu** (page 49), select **“PHOTO STABILIZER”**, and press the **SET** button.

: Motion compensation is enabled.



: Motion compensation is not enabled.

- 2 Select the desired setting, and press the **SET** button.
 - This completes the photo stabilizer setting.

HINT**If the motion compensation does not seem to be working...**

- Due to the mechanical characteristics of this function, it may not be possible for the camera to compensate for violent motion.
- If the digital zoom (page 81) is being used, the large magnification factor may make it difficult for the motion compensation function to work correctly.

Can't set the "photo stabilizer" setting?

- The photo stabilizer is automatically turned off  after any of the following operations.
 - Pressing the flash button [] to open the flash unit.
 - Setting the exposure to **S**, **A** or **M** (page 114).
 - Setting the still image NR (noise reduction) setting (page 150) to "ON".
 - Setting the flicker reduction setting (page 152) to "ON".
 - Starting video clip recording.
 - Setting the camera to the sequential shots mode (page 95).





Did the field angle change?

- When motion compensation is enabled, the field angle changes when capturing still images.

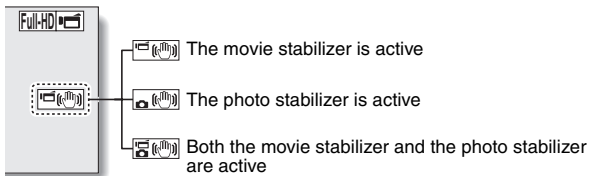
When motion compensation is enabled,

- The following icons are shown on the monitor:

**Did the scene select setting change?**

- When the motion compensation is set to , if the scene select setting is , , or , it will automatically change to **AUTO**.

FOCUS RANGE

1 Display the NORMAL Mode Shooting Menu (page 49), select “FOCUS”, and press the SET button.

- When shooting a subject at a medium to far distance, by setting the focus range to , you will find it both easier and faster to focus.

: Wide end: 10 cm (3.94 in.) to infinity
Tele end: 1 m (3.28 ft.) to infinity (total range mode)

: 80 cm (31.50 in.) to infinity (normal mode)

: The focus can be manually set to any distance from 1 cm (0.39 in.) to 40 m (131.23 ft.), as well as to infinity (manual focus).

: 1 cm (0.39 in.) to 1 m (3.28 ft.) (super macro mode: wide end only)

- When the focus range is set to ,  or , the corresponding indication appears on the monitor.

2 Select the desired icon, and press the SET button.

- This completes the focus range setting.

HINT

- When the focus range is set to super macro , the zoom is temporarily set to the wide end.
- By assigning an operation shortcut to the SET button (page 148), you can change the focus range setting from the Shooting Screen.

How to use the manual focus

- 1 Display the **NORMAL Mode Shooting Menu** (page 49), select **“FOCUS”**, and press the **SET** button.

- 2 Select **“MANUAL”**, and press the **SET** button.

- The focus distance adjustment bar appears.



- 3 Toggle the **SET** button to the left or right to adjust the focus distance, and press the **SET** button.

- The focus distance is set, and you are returned to the Shooting Screen.

HINT

About the focus range

- The focus distance indication shows the distance between the center of the lens and the subject.
- In some cases there may be a slight variance between the distance (numerical figure) you set in the manual focus mode and the actual distance.

About zoom movement when using the manual focus

- If the focus distance is set to 70 cm (27.56 in.) or less, the zoom changes to the largest setting that is suitable for that focus distance.
- When the focus distance is set to 70 cm (27.56 in.) or less, the zoom will function only within the range at which the image is focused.

FOCUS MODE

You can choose from the following 2 types of autofocus (still image shooting only):

9-point range finder focus:

The correct focus is determined from 9 different focus points within the shooting area visible on the monitor. When the image is focused, a target mark  appears.

Spot focus:

The camera focuses on the subject in the center of the monitor.

1 Display the NORMAL Mode Shooting Menu (page 49), select “FOCUS MODE”, and press the SET button.

: 9-point range finder focus is selected.

: Spot focus is selected.

2 Select the desired icon, and press the SET button.

- The focus mode is set.
- When the spot focus setting is selected, the focus mark + appears in the center of the monitor.

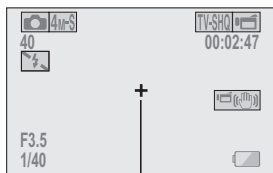

Focus mark

LIGHT-MEASURING MODE SETTING

You can select from 3 types of light-measuring modes.

Multi-section light-measuring:

The light is modulated after sampling from multiple areas of the entire shooting screen.



Center-weighted light-measuring:

The light is modulated for the entire image after measuring from mostly the center area.

Spot light-measuring:

You can compose the picture and capture the image after first modulating the light only at the center spot of the monitor.

- 1 Display the **NORMAL Mode Shooting Menu** (page 49), select “**EXP MEASURE**”, and press the **SET** button.

- : Multi-section light-measuring
- : Center-weighted light-measuring
- : Spot light-measuring

- 2 Select the desired light-measuring mode, and press the **SET** button.

- This completes the light-measuring mode setting.
- When spot light-measuring is selected, the light-measuring spot mark  appears in the center of the monitor.

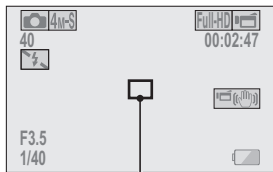

Light-measuring spot mark

ISO SENSITIVITY

With the initial settings, the ISO sensitivity is automatically set according to the brightness of the subject. However, the ISO sensitivity can be set to a fixed setting.

1 Display the NORMAL Mode Shooting Menu (page 49), select “ISO”, and press the SET button.

AUTO: The ISO sensitivity is set automatically (video clip recording: ISO 50 to 800; still image shooting: ISO 50 to 200).

50: Sets sensitivity to ISO 50.

100: Sets sensitivity to ISO 100.

200: Sets sensitivity to ISO 200.

400: Sets sensitivity to ISO 400.

800: Sets sensitivity to ISO 800.

1600: Sets sensitivity to ISO 1600.

3200: Sets sensitivity to ISO 3200 (video clip recording: ISO 1600).

*The indicated ISO value is the standard output sensitivity.

2 Select the desired icon, and press the SET button.

- This completes the ISO sensitivity setting.

HINT

- When the ISO sensitivity is set to **3200**, video clips, as well as still images captured during video clip recording, will be recorded at ISO **1600**.
- By setting a higher ISO sensitivity, you can set faster shutter speeds and capture images in darker locations, but noise in the captured images may increase or the images may be irregular.
- By assigning an operation shortcut to the SET button (page 148), you can change the ISO setting from the Shooting Screen.

CAUTION**Does the image appear to flicker when recording a video clip?**

- If recording a video clip under fluorescent lights with the ISO sensitivity set to **400** or higher, a noticeable flicker may appear in the image.

WHITE BALANCE

This camera automatically adjusts the white balance under most lighting conditions. However, if you want to specify the lighting conditions or change the overall tone of the image, the white balance can be manually set.

1 Display the NORMAL Mode Shooting Menu (page 49), select “WHITE BALANCE”, and press the SET button.

: The camera will make the white balance adjustment automatically based on the natural and artificial light conditions.

: For shooting outside on a sunny day.

: For shooting outside on a cloudy day.

: For shooting inside under fluorescent lighting.

: For shooting inside under incandescent lighting.

: This setting is used for a more accurate white balance using the existing light source (one push). Please use it when the light source cannot be identified, for example.

Setting procedure

① Select the  icon.

② Fill the entire screen with a plain white card (or piece of paper, etc.), and press the SET button.

- This completes the white balance setting.
-

2 Select the desired icon, and press the SET button.

- This completes the white balance setting.
-

HINT

To cancel the white balance setting

- Perform step 1, select , and then press the SET button.

EXPOSURE SETTING

The shutter speed and aperture size can be set individually by the user.

1 Display the **NORMAL Mode Shooting Menu** (page 49), select **“EXPOSURE”**, and press the **SET** button.

- P**: The optimum shutter speed and aperture size are set according to the brightness of the subject (aperture and shutter variable program AE).
Example: For simple shooting with minimum setup, using the camera's automatic settings.
- S**: This allows you to set a specific shutter speed. The camera automatically sets an appropriate aperture size based on this setting (shutter speed priority AE).
Example: To set a fast shutter speed for capturing a clear image of a fast-moving object, or to set a slow shutter speed to shoot the flow of a background scene.
By using the flash in combination with a slow shutter speed, you can create beautiful photographs of people against a background night scene (slow synchro photography).
- A**: This allows you to set a specific aperture size. The camera automatically sets an appropriate shutter speed based on this setting (aperture priority AE).
Example: To open the aperture for portraits with a blurred background (for a shallow field depth), or to close the aperture for a clear foreground and background (for a deep field depth).
- M**: This allows you to set a specific shutter speed and aperture size (manual exposure control).
Example: When shooting in a dark location without using the flash, set the shutter to stay open for a longer time (slow shutter). When used for shooting nighttime scenes, you can capture lights flowing across the image.

EXPOSURE SETTING

2 Select the desired icon from the exposure menu, and press the SET button.

<If **[S]**, **[A]** or **[M]** was selected>

- ① Toggle the SET button up or down to select aperture value or shutter speed.
- ② Toggle the SET button left or right to change the setting for the selected parameter.

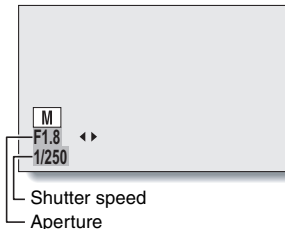

3 Press the SET button.

- This completes the exposure setting.

HINT

- To prevent the effects of camera shake at slow shutter speeds, it is recommended to use a tripod or other method to stabilize the camera.
- A slow shutter speed may be useful for photographing in a darker environment, but noise in the image may be increased.
- To minimize noise in the image, enable the noise reduction function (page 150).
- The exposure setting automatically becomes **[P]** if the scene select function is active.
- In the sequential shots mode, the shutter speed is faster than 1/15 sec.
- Even if the shutter speed is set to slower than 1/59 sec., the shutter speed during video clip recording is 1/60 sec.
- If the exposure setting is set to **[S]**, **[A]** or **[M]**, by assigning an operation shortcut to the SET button (page 148), you can select the **[S]**, **[A]** or **[M]** exposure setting from the Shooting Screen.

DIGITAL ZOOM SETTING

This setting allows you to specify whether or not the digital zoom is enabled during zoom shooting.

- 1** Display the **NORMAL Mode Shooting Menu** (page 49), select **"DIGITAL ZOOM"**, and press the **SET** button.

: Digital zoom can be used.

: Digital zoom cannot be used.

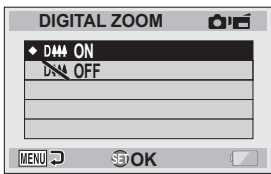

- 2** Select the desired setting, and press the **SET** button.
 - This completes the digital zoom setting.

HINT

- The digital zoom does not function in the following situation:
When the still image mode is set to **8M**.

FACE CHASER

As you capture a still image, the face chaser detects the subject's face, and adjusts the brightness and focus in a way that produces a clear and bright photo of the subject's face.

1 Display the NORMAL Mode Shooting Menu (page 49), select "FACE CHASER", and press the SET button.

: The face chaser function is enabled.

: The face chaser function is not enabled.

2 Select the desired setting, and press the SET button.

- This completes the face chaser setting.
-

HINT

When the face chaser is set to ON...

- Each face in the Shooting Screen is marked with a green frame.
- Faces that are in focus are marked with a double green frame.
- If you press the [] button halfway, the frames marking the faces that are in focus change to orange.

If you magnify an image that was captured with the face chaser function enabled, the magnified image will center on the face(s).

- The scene select function setting automatically changes to **AUTO**.
-

CAUTION

- The digital zoom is disabled.
- The face chaser function does not work when zooming in or out.
- The face chaser function may not work when the subject's face in the monitor is relatively small or appears dark.

HIGH SENSITIVITY MODE

When you shoot in the high sensitivity mode, the captured image appears even brighter than that specified by the ISO sensitivity and exposure compensation settings.

- 1** Display the **NORMAL Mode Shooting Menu** (page 49), select “**HIGH SENSITIVITY**”, and press the **SET** button.



: The high sensitivity mode is activated.

: The high sensitivity mode is not activated.

- 2** Select the desired setting, and press the **SET** button.
 - This completes the high sensitivity mode setting.
-

CAUTION

Limitations of the high sensitivity mode

- If the exposure (page 114) is set to ,  or , or if the flicker reduction function (page 152) is set to “ON”, the high sensitivity mode automatically changes to “OFF”.
- When the shutter speed is reduced to create a bright image, video clip motion will appear uneven during playback.
- When shooting in a dark environment, the autofocus and auto exposure may not function effectively.

EXPOSURE COMPENSATION

By assigning the exposure compensation operation shortcut to the SET button (page 148), you can make the image lighter or darker when capturing images.

1 Assign the operation shortcut to the SET button (page 148).

2 Toggle the SET button in the direction for which the operation shortcut was assigned.

- The exposure compensation bar appears.

3 Toggle the SET button to the left or right to adjust the exposure.

- The exposure compensation numerical value is shown at the left end of the exposure compensation bar.
- The exposure compensation can be set to a value from -1.8 EV to $+1.8$ EV.
- The exposure compensation bar is canceled when the MENU button or the SET button is pressed.

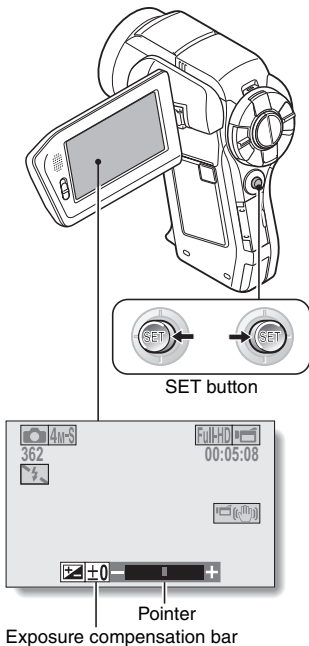

HINT

The exposure compensation setting is canceled in the following cases:

- When the pointer is set to the center position.
- When the camera is set to the playback mode.
- When the standby mode or sleep mode is activated.
- After the power is turned off.

SLIDESHOW PLAYBACK

Specify the settings for playing back files continuously in a “slideshow” format. In a slideshow of still images, you can set the transition time, transition effects and BGM.

- 1** Display the **NORMAL Mode Playback Menu (page 49)**, select “**SLIDESHOW**”, and press the **SET** button.

MODE:

Specify the file type to play back.

ALL:

Play back all files.

MOVIE:

Play back video clips and audio files.

PHOTO:

Play back still image files.

TIME:

Adjust the transition speed (the period that an image is displayed before it changes to the next image).

EFFECT:

Select a transition effect as an image changes to the next image.

BGM:

Specify the settings for playing background music during slideshow playback.

START:

Begin slideshow playback.

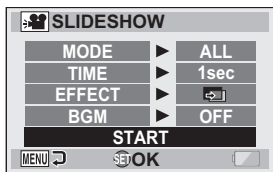

<Changing a setting>

- ① Select the item you wish to change, and press the **SET** button.
- ② Toggle the **SET** button up or down to change the setting.
- ③ Press the **SET** button.

SLIDESHOW PLAYBACK

2 Select “START” and press the SET button.

- Slideshow playback begins.
- To stop slideshow playback, press the SET button or MENU button.

HINT

BGM for video clips?

- When video clips are played back in a slideshow, the recorded audio track is played back; the BGM is not played.

FILE PROTECT

Prevent accidental erasure of image and audio files.

- 1** Display the file that you want to protect from accidental erasure, and display the **NORMAL Mode Playback Menu** (page 49).
-

- 2** Select **“PROTECT”** and press the **SET** button.

- “LOCK” appears.
 - If the protect mode has already been enabled for the file, then “UNLOCK” appears.
-



- 3** Toggle the **SET** button up or down to select **“LOCK”**, and press the **SET** button.

- The protect mode is set for the file.
- The protect mark  indicates that the file is locked.

CAUTION

- Even if the protect mode is set for certain files, they will be deleted if the card is reformatted (page 165).
-

HINT

To select a different image in steps 2 and 3...

- Toggle the **SET** button to the left or right.

To cancel the protect mode for a file...

- Display the desired file and repeat steps **1** to **3**. The protect mark  will disappear and the protect mode is canceled.

PRINTING INSTRUCTIONS

In addition to using your printer to print out still images captured with your camera, as with conventional film, you can have prints made at shops offering digital print services. Moreover, this camera is DPOF-compatible, so you can use the camera to specify the number of prints, whether or not the date is displayed on the print, and also to request an index print.

Display the Printing Instructions Screen

- 1 Display the **NORMAL Mode Playback Menu** (page 49), select **"PRINT INSTRUCTIONS"**, and press the **SET** button.

ALL IMAGES:

The specified printing instructions apply to all the images.

EACH IMAGE:

The printing instructions are specified for each individual image.

INDEX:

All the still images are printed as miniature images (thumbnail images), several images on one print.

ALL CLEAR:

Clear all the printing instructions. This cannot be selected if no printing instructions have been specified for the image.

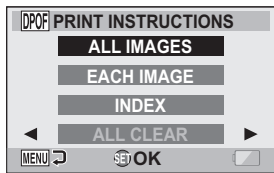

HINT**Printing a single frame from a video clip**

- To print with a printer or have the digital print service shop print out a still image from a video clip, you must first save it (extract still) as a still image (page 131).

About the DPOF format

- DPOF (Digital Print Order Format) is a print order format. You can connect your camera to a DPOF-compatible printer to produce your prints. You can also set the printing instructions for the desired images, and then have the requested images printed automatically (page 184).

About the finished prints

- Rotated images (page 129) will be printed in their original orientation.
- The quality of the print output will differ depending on the print service and printer used.

PRINTING INSTRUCTIONS

Specifying date imprinting and print quantities

You can specify printing instructions for each individual image (EACH IMAGE), or apply the printing instructions to all the images (ALL IMAGES).

1 Display the Printing Instructions Screen (page 123).

2 Select “ALL IMAGES” or “EACH IMAGE”.

ALL IMAGES:

The printing instructions are applied to all the images.

EACH IMAGE:

The printing instructions are applied only to the image currently displayed.

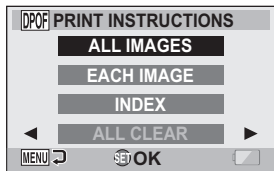

3 Press the SET button.

- The Date/Copies Print Screen appears.
- If “EACH IMAGE” was selected, toggle the SET button to the left or right to display the desired image to print.
- The printing instructions that are currently active for the displayed image are shown. You can toggle the SET button to the left or right to confirm the printing instructions for each image.

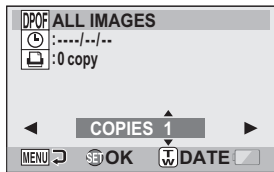

Printing instructions

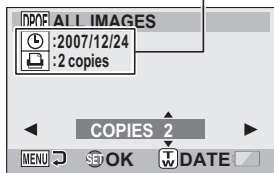

<Completed printing instructions>

4 Specify whether the date is displayed on the print, and the number of prints.

<Specify the number of prints>

- Toggle the SET button up or down.
 - The quantity indication changes.
 - Display the desired number of prints.
- Press the SET button.
 - The number of prints is set.

<Specify dated prints>

- From the screen on which the number of prints is set, press the zoom switch.
- Press the SET button.

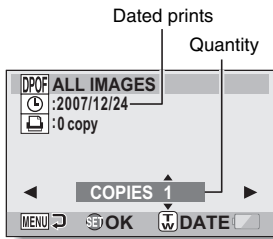

5 Press the MENU button.

- The printing instructions for the requested print quantities and dated prints are stored.
- The display returns to the Printing Instructions Screen.

HINT

If the message “Date not set for photo” appears...

- Dated prints are not possible for photos that were captured before the camera’s date and time setting was completed.
- After the message “Date not set for photo” appears, you are returned to the NORMAL Mode Playback Menu.

PRINTING INSTRUCTIONS

Index print

Printing out many small images on one sheet is called an “index print”. This is convenient for use as a list of the images you have captured.

1 Display the Printing Instructions Screen (page 123).

2 Select “INDEX”.

3 Press the **SET** button.

- The Index Print Screen appears.

OK:
Specify an index print copy.

EXIT:
Discontinue the setting procedure, and return to the Printing Instructions Screen.

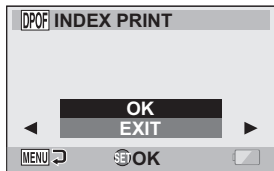

4 Select “OK”, and press the **SET** button.

- This completes the setting for the index print. You are returned to the Printing Instructions Screen.

HINT

To cancel the index print setting

- Follow steps 1 and 2, select “CLEAR” in step 3, and press the SET button.

Clearing all the printing instructions

Delete the printing instructions for all images.

1 Display the Printing Instructions Screen (page 123).

2 Select “ALL CLEAR”.

3 Press the SET button.

- The Confirm All Clear Screen appears.

CANCEL:

Clear the printing instructions for all images.

EXIT:

Cancel the clear procedure and return to the Printing Instructions Screen.

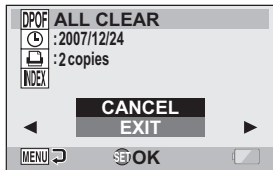

4 Select “CANCEL”, and press the SET button.

- All the printing instructions are cleared and you are returned to the Printing Instructions Screen.

ROTATE STILL IMAGE

Captured still images can be rotated to the correct orientation for viewing.

- 1** Display the still image you wish to rotate, and display the **NORMAL Mode Playback Menu** (page 49).
-

- 2** Select **"ROTATE"**, and press the **SET** button.

RIGHT:

Rotates image clockwise
90 degrees.

LEFT:

Rotates image counterclockwise
90 degrees.

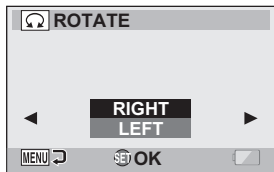

- 3** Select **"RIGHT"** or **"LEFT"**, and press the **SET** button.

- Each time the SET button is pressed, the image is rotated another 90 degrees.
-

HINT

- An image for which the protect mode has been enabled cannot be rotated. To rotate a protected image, cancel the protect mode before beginning the rotate image procedure (page 122).

REDUCE STILL IMAGE SIZE (RESIZE)

A captured image can be resized to a smaller size and saved as a separate image.

- 1 Display the still image whose size you want to change, and display the **NORMAL Mode Playback Menu** (page 49).

- 2 Select **"RESIZE"**, and press the **SET** button.
<For still images with a 4:3 vertical-to-horizontal aspect ratio>

2M (4:3): The size changes to 1600 × 1200 pixels.

0.3M (4:3): The size changes to 640 × 480 pixels.

<For still images with a 16:9 aspect ratio>

2M (16:9): The size changes to 1920 × 1080 pixels.

0.9M (16:9): The size changes to 1280 × 720 pixels.



- 3 Select the new image size, and press the **SET** button.

- 4 Select **"SAVE"** and press the **SET** button.
 - Resizing begins.

HINT

Why can't the image be resized?

- An image can be resized only to a smaller (or the same) size, not to a larger size.

EXTRACTING ONE FRAME FROM A VIDEO CLIP

You can select one image (scene) from a video clip, copy it, and save it as a still image (the original file remains unchanged).

1 Play back a video clip, and pause at the point you wish to copy and save.

2 Display the **NORMAL Mode Playback Menu** (page 49), select **“EXTRACT STILL”**, and press the **SET** button.

16:9:

The currently displayed image will be saved as a still image with an aspect ratio of 16:9. (This selection is available only for video clips recorded in the HD mode.)

4:3:

The currently displayed image will be saved as a still image with an aspect ratio of 4:3.

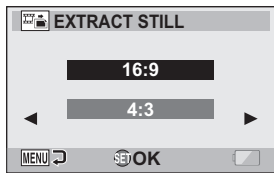

3 Select **“16:9”** or **“4:3”**, and press the **SET** button.

- The screen to confirm that you wish to save the image appears.

SAVE:

Save the currently displayed image as a still image.

EXIT:

You are returned to the screen to extract an image.

4 Select **“SAVE”** and press the **SET** button.

- The currently displayed image is saved as a still image.

EDITING VIDEO CLIPS

You can trim away unwanted portions from a video clip and save it as a new video clip (video clip cutting [extracting]). You can also join video clips together and save them as one separate clip ("joining").

Procedure to cut (extract) a portion of a video clip

Specify the frames (①, ②) where the video clip is to be cut.

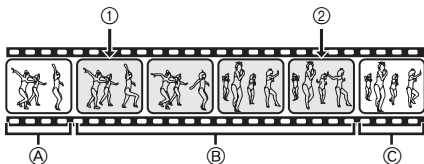

Extract the specified portion.

[Two ways to cut the video clip]

- Trim away portions ① and ②, and save portion ③.



- Delete portion ②, and join portions ① and ③.



- The original video clip is not affected.



(You can also choose to erase the original video clip when the new clip is saved.)

EDITING VIDEO CLIPS

Procedure to join video clips

Specify the video clip that will come first.



Specify the video clip that you wish to append (join).



Join the video clips.

- The video clips are joined.

..



- The original video clips are not affected.
(You can also choose to erase the original video clips when the new clip is saved.)



CAUTION

Caution when editing video clips

- When editing video clips, do not move the REC/PLAY switch. If you move the REC/PLAY switch while editing video clips, not only will the editing not be properly completed, but the original video clip may also be erased.
- As the number or size of the video clips increases, the card memory may become full, making it impossible to edit the video clips. In this case, you will need to free some of the memory on the card, either by deleting files that are no longer necessary (page 88), or by selecting "OVERWRITE" when saving edited video clips (pages 136 and 138).

Video clip cutting (extracting)

1 Display the video clip from which you wish to extract a segment.

2 Display the NORMAL Mode Playback Menu (page 49), select “EDIT VIDEO”, and press the SET button.



3 Select “CUT” and press the SET button.

- The Cutting Screen appears.

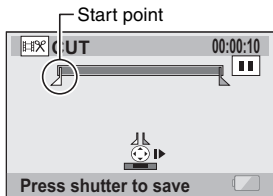

EDITING VIDEO CLIPS

4 Specify the start point of the extract.

- Use the procedure below to specify the frame from which the video clip extract will start.
- Play the video clip until approximately the desired point, pause the video clip, then play the video clip one frame at a time, stopping at the start point of the extract. This will be the first frame of the extract.
- If the start point of the video clip is also the start point of the extract, proceed to step 6.

<Procedure>

Play:

After pausing playback, press and hold the SET button to the right for about 2 seconds for forward playback, or to the left for reverse playback.

Pause:

During playback, press the SET button.

Accelerated playback:

During playback, toggle the SET button to the left or right to change the playback speed.

Single frame:

After pausing playback, toggle the SET button to the right to move forward one frame, or to the left to move back one frame.

5 Toggle the SET button up.

- The start point of the video clip extract is set, and the screen to specify the end point appears.
- Specify the end point of the extract by following the same procedure as in step 5.

<When joining the first and latter portions>

- ① Toggle the SET button down.
 - Each time the SET button is toggled down, the sections to delete and the sections to save are reversed.
- ② Specify the end point of the extract. The frame following the end point of the extract will be the start point of the latter portion to be joined.

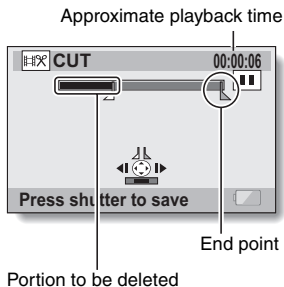

6 Press the [] button.

- A screen appears for you to select either to save the edited video clip as a new (separate) file, or to delete the original video clip and replace it with the edited video clip.

SAVE AS NEW:

The edited video clip will be saved as a new file. The original video clip remains unchanged.

OVERWRITE:

The original video clip will be deleted. Only the edited video clip will be saved.

REVIEW CLIP:

Play back the edited video clip before saving it.



7 Select the desired option, and press the SET button.

- Editing starts.
- When editing ends, you are returned to the NORMAL Mode Playback Menu.

HINT

- If the original video clip is protected, even if you select "OVERWRITE" in step 7 and press the SET button, the original video clip will not be erased. If you want it to be erased, you will need to first remove the protection (page 122).
- If the "Card full" message appears, you will need to free some of the memory by deleting files that you do not need to keep.

CAUTION

Warning concerning the battery pack remaining charge

- During the editing of lengthy video clips, the time to process the large amount of data can become quite long. To avoid problems caused by the battery pack becoming depleted in the middle of video clip editing, before starting to edit be sure that a sufficiently charged battery pack is installed in the camera, or connect the AC adaptor.
- It is recommended that a computer be used to edit long video clips.

EDITING VIDEO CLIPS

Joining video clips

CAUTION

- Video clips that were photographed in different modes cannot be joined.

-
- 1** Display the **NORMAL Mode Playback Menu (page 49)**, select **“EDIT VIDEO”**, and press the **SET** button.



- 2** Select **“JOIN”** and press the **SET** button.
 - The 6-image playback display for video clips appears.



3 Move the orange frame to the video clip you wish to join, and press the **SET** button.

- The specified video clip is labeled with a number.
- Up to 9 video clips can be selected.
- To cancel a selection and remove the number label from a video clip, select the video clip and press the **SET** button.



4 Press the [] button.

- A screen appears for you to select either to save the joined video clip as a new (separate) file, or to delete the original video clips and replace them with the joined video clip.

SAVE AS NEW:

The joined video clip will be saved as a new file. The original video clips remain unchanged.

OVERWRITE:

The original video clips will be deleted. Only the joined video clip will be saved.

REVIEW CLIP:

Play back the joined video clip before saving it.

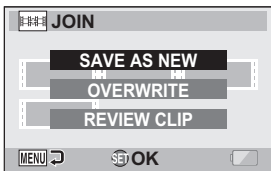

EDITING VIDEO CLIPS

5 Select the desired option, and press the SET button.

- Editing starts.
- When editing ends, you are returned to the Playback Setting Screen.

HINT

- If the original video clip is protected, even if you select "OVERWRITE" in step 5 and press the SET button, the original video clip will not be erased. If you want it to be erased, you will need to first remove the protection (page 122).
- If the "Card full" message appears, you will need to free some of the memory by deleting files that you do not need to keep.

CAUTION

Warning concerning the battery pack remaining charge

- During the editing of lengthy video clips, the time to process the large amount of data can become quite long. To avoid problems caused by the battery pack becoming depleted in the middle of video clip editing, before starting to edit be sure that a sufficiently charged battery pack is installed in the camera, or connect the AC adaptor.
- It is recommended that a computer be used to edit long video clips.

DISPLAYING FILE PROPERTIES (INFORMATION SCREEN)

On the Information Screen you can check what the settings were when a file was recorded with your camera.

1 Display the desired file on the camera monitor.

2 Press the MENU button for at least 1 second.

- The Information Screen appears.
- If the MENU button is pressed again, the Information Screen is canceled.

- ① Video clip mode settings
- ② Image or sound number
- ③ Protect setting
- ④ File size
- ⑤ Shooting or recording time
- ⑥ Exposure compensation setting
- ⑦ Aperture value
- ⑧ Shutter speed
- ⑨ Remaining battery charge
- ⑩ Date and time of image
- ⑪ Still image resolution settings
- ⑫ ISO sensitivity setting

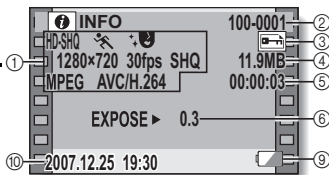

<Video clip file>

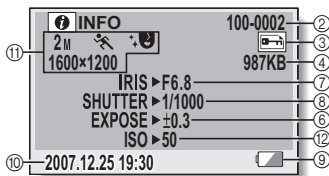

<Still image file>

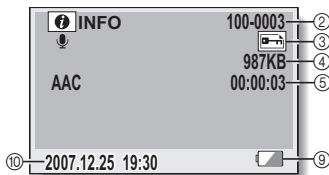

<Audio file>

DISPLAY THE OPTION SETTING MENU

The camera settings are executed via the Option Setting Menu.

- 1** Turn on the camera, and press the MENU button.

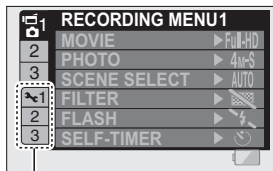

Option tab

- 2** Select an Option tab (1, 2 or 3), and press the SET button.

- The Option Setting Menu appears.

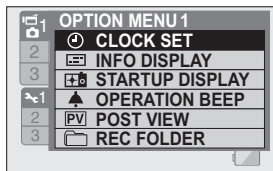

To access a Setting Screen

- 3** Toggle the SET button up or down to select the item you wish to set, and press the SET button.

- The Setting Screen for the selected item appears.
- To return to the Menu Screen, press the MENU button.

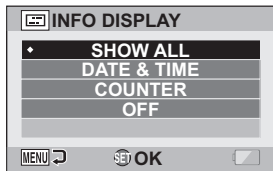

SCREEN DISPLAY

Specify what information is displayed on the Playback Screen.

1 Display the Option Setting Menu (page 141).

2 Select “INFO DISPLAY”, and press the SET button.

SHOW ALL:

Display the capture date and playback time (for video clips).

DATE & TIME:

Display the capture-date.

COUNTER:

Display the video clip playback time.

OFF:

Do not display the capture date and playback time.

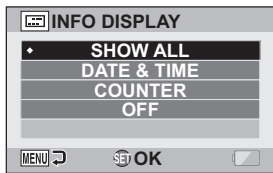

3 Select the desired setting, and press the SET button.

- This completes the screen display setting.

SELECT THE STARTUP DISPLAY

The startup display is the display that appears on the monitor when the camera is turned on in the recording mode.

1 Display the Option Setting Menu (page 141).

2 Select "STARTUP DISPLAY", and press the SET button.

DATE & TIME:

The camera's date and time setting is shown.

Xacti:

The Xacti logo is shown.

OFF:

No startup display.

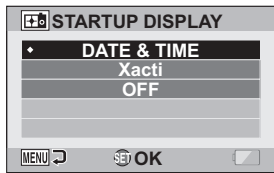

3 Select the desired setting, and press the SET button.

- The selected startup display is set.

OPERATION SOUNDS

Use this menu to set the confirming audio signals when the camera is turned on/off or when the operation buttons ([] button, SET button, MENU button, etc.) are pressed, to adjust the operation sound volume, and to enable/disable the audio guide.

1 Display the Option Setting Menu (page 141).

2 Select “OPERATION BEEP”, and press the SET button.

- If “ALL OFF” is selected and the SET button pressed, all the operation sounds are muted.
- If the MENU button is pressed, you are returned to the Option Screen.

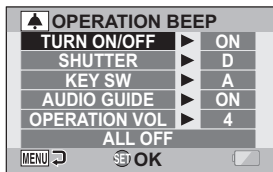

TURN ON/OFF:

Mute or enable the sound that is produced when the power is turned on or off.

SHUTTER:

Select the sound that is produced when the [] button is pressed, or when a photo is taken using the self-timer.

KEY SW:

Select the sound that is produced when the SET button, MENU button, etc. are pressed.

AUDIO GUIDE:

Mute or enable the camera's audio help guide.

OPERATION VOL:

Adjust the volume of the operation sounds.

OPERATION SOUNDS

3 Toggle the SET button up or down to select the desired setting, and press the SET button.

- The screen to select operation sounds appears.

<If "TURN ON/OFF" or "AUDIO GUIDE" is selected>

- The respective screen to enable or disable the sound appears.
- Toggle the SET button up or down to select the desired setting, and press the SET button.

ON: Activates the sound.

OFF: Deactivates the sound.

<If "SHUTTER" or "KEY SW" is selected>

- The screen to select the operation sounds appears.
- Select from 8 different sounds (A to H).
- You can toggle the SET button right to preview the selected operation sound.
- If "OFF" is selected, no sound is produced.
- Toggle the SET button up or down to select the desired setting, and press the SET button.

<If "OPERATION VOL" was selected>

- The screen to select the volume for the operation sounds appears.
- You can select an operation sound volume from 1 (minimum) to 7 (maximum).
- Toggle the SET button up or down to select the volume, and press the SET button.

4 Press the MENU button.

- The operation sound settings are completed.

HINT

- If you keep the MENU button pressed and turn on the power, the screen to turn the operation sounds ON/OFF appears at once. You may find this a convenient procedure to disable the operation sounds in places you do not want them to be audible.

POST-VIEW DISPLAY SETTING

Specify the duration that the captured image appears on the monitor (post-view) after the [] button is pressed.

1 Display the Option Setting Menu (page 141).

2 Select "POST VIEW", and press the SET button.

1 sec:

The post-view image is displayed for 1 second.

2 sec:

The post-view image is displayed for 2 seconds.

OFF:

The post-view image is not displayed.

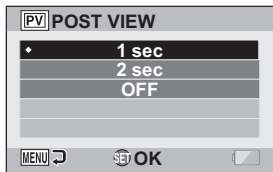

3 Select the desired setting, and press the SET button.

- This completes the post-view setting.

SPECIFY A FOLDER TO SAVE FILES

Create or select a recording folder (a folder in which to store recorded files).

1 Display the Option Setting Menu (page 141).

2 Select “REC FOLDER”, and press the SET button.

<Create a new folder>

- Select “NEW”.

<Select an existing folder>

- Select the desired folder number.



3 Press the SET button.

- This completes the create/select folder setting.
 - If you created a new folder, it automatically becomes the selected recording folder.
-

CAUTION

When an existing folder cannot be selected or a new one created...

- A folder cannot be selected if it was created using a different device, or if it already contains the maximum number of files.

ASSIGN SET BUTTON FUNCTIONS

Assign functions (operation shortcuts) to the SET button when it is toggled up, down, left or right when the Shooting Screen is displayed.

1 Display the Option Setting Menu (page 141).

2 Select "SHORTCUTS", and press the SET button.

- : Assign the function when the SET button is toggled up.
- : Assign the function when the SET button is toggled down.
- : Assign the function when the SET button is toggled to the left.
- : Assign the function when the SET button is toggled to the right.

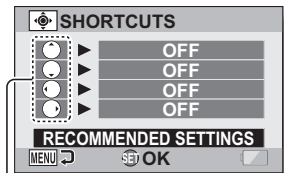

SET button operations

RECOMMENDED SETTINGS:

The most commonly used settings are automatically assigned.

3 Select the SET button operation to which you wish to assign the function, and press the SET button.

- The screen to assign a function to the key appears.

OFF: No operation shortcut is assigned to the key.

AF LOCK: Lock the focus (page 76).

FOCUS: Set the focus range (pages 72 and 107). (This operation shortcut can be assigned only to the ○ or ○ key.)

FLASH: Set the flash operation (pages 77 and 102).

EXP COMPENSATION: Adjust the exposure (page 119).

ISO: Set the ISO sensitivity (page 111).

SELF-TIMER: Set the self-timer (page 103).

EXPOSURE: Set the exposure value for the exposure setting (page 114).

ASSIGN SET BUTTON FUNCTIONS

4 Toggle the SET button up or down.

- Display the function you wish to assign to the key.

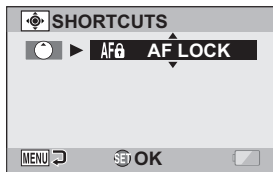

5 Press the SET button.

- The selected function is assigned to the key, and you are returned to the Shortcuts Screen.
- To assign functions to the other keys, repeat steps 3 through 5.

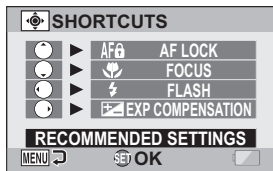

<When "RECOMMENDED SETTINGS" is selected>

6 Press the MENU button.

- The screen to confirm the shortcut settings appears, and then you are returned to the Option Setting Menu.
- This completes the shortcuts setting.

<To confirm the assigned shortcuts>

- On the screen in step 2, press the MENU button, and the screen to confirm the shortcut settings appears.



NOISE-REDUCTION FUNCTION

Image noise when recording video clips or still images, as well as audio noise such as from the wind, can be minimized with the noise-reduction function.

1 Display the Option Setting Menu (page 141).

2 Select "NOISE REDUCTION", and press the SET button.

MOVIE NR:

Set ON/OFF the function to reduce image noise when recording a video clip.

PHOTO NR:

Turn ON/OFF the image noise reduction function during still image shooting.

WIND SOUND NR:

Turn ON/OFF the wind noise reduction function during video clip/audio recording.

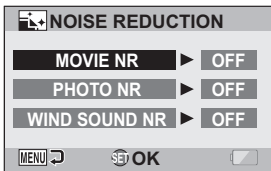

3 Select the desired function and press the SET button.

- The screen to select ON or OFF appears.

ON:

Noise is reduced.

OFF:

Noise is not reduced.

4 Toggle the SET button up or down to select the desired setting, and press the SET button.

- This completes the noise reduction setting.

HINT

- The wind sound NR setting should normally be set to OFF when it is not necessary. If it is used when recording a video clip or audio file in an environment where there is no noise, the recording will sound unnatural.
- The still image NR function is effective when the shutter speed is 1/4 second or less.
- Compared to normal shooting, when the still image NR function is enabled, the image processing time after shooting a still image is slightly longer.

ADJUST THE IMAGE QUALITY

The camera can adjust the image quality as the image is captured.

1 Display the Option Setting Menu (page 141).

2 Select "IMAGE SETTINGS", and press the SET button.

NORMAL:

Shoot with image quality at normal.

VIVID:

Color saturation is increased.

SOFT:

The sharpness is subdued for a softer image.

SOFT VIVID:

The sharpness is softened and color saturation is increased.

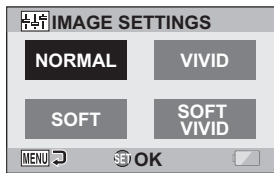

3 Select the desired setting, and press the SET button.

- This completes the image quality setting.

FLICKER-REDUCTION

The flicker-reduction setting reduces the flicker that results when filming video clips under fluorescent lights and the like where the background lighting pulsates at the frequency of the power supply.

1 Display the Option Setting Menu (page 141).

2 Select “FLICKER REDUCT”, and press the SET button.

ON:

Turns on the flicker-reduction setting.

OFF:

Turns off the flicker-reduction setting.

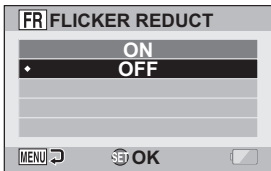

3 Select the desired setting, and press the SET button.

- This completes the flicker-reduction setting.
-

HINT

- If the flicker-reduction setting is used outdoors on a very bright day, a halation effect, which produces diffused rings of light around bright light areas, may occur.
- The exposure setting and flicker reduction function cannot both be enabled at the same time.
- When the flicker-reduction function is set to “ON”, the shutter speed during video clip recording becomes 1/100 sec.

MONITOR BRIGHTNESS

Adjust the brightness of the camera's monitor display. Use this adjustment when the monitor image is difficult to view because of ambient lighting.

1 Display the Option Setting Menu (page 141).

2 Select "BRIGHTNESS", and press the SET button.



3 Toggle the SET button to the left or right to set the brightness, and press the SET button.

- The monitor brightness is set.

HINT

- The display in step 2 can also be accessed from the Shooting Screen. Press the MENU button for at least 1 second; the brightness control display will appear, and you can then adjust the monitor brightness.

ADJUST THE VOLUME OF AN EXTERNAL MICROPHONE

The input level of a microphone connected to the camera can be adjusted.

1 Display the Option Setting Menu (page 141).

2 Select “EXT MIC VOLUME”, and press the SET button.

3 Toggle the SET button to the left or right to adjust the input level, and press the SET button.

- This completes the input level setting for the external microphone.

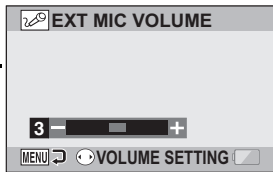

SCREEN LANGUAGE

You can set the monitor of your camera to display the messages in any one of several languages.

1 Display the Option Setting Menu (page 141).

2 Select "LANGUAGE", and press the SET button.

日本語 :	Japanese
ENGLISH:	English
FRANCAIS:	French
DEUTSCH:	German
ESPAÑOL:	Spanish
ITALIANO:	Italian
NEDERLANDS:	Dutch
РУССКИЙ :	Russian
PORTUGUÊS:	Portuguese
TÜRKÇE:	Turkish
한국어:	Korean
中文(简):	Chinese (simplified)
中文(繁):	Chinese (traditional)

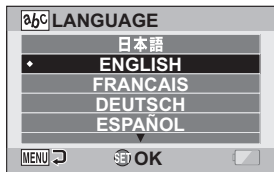

3 Select the desired language, and press the SET button.

- The selected display language is set.

TV OUTPUT SETTING

Specify the type of image signal that is output from your camera's USB/AV terminal, COMPONENT/AV terminal or HDMI terminal.

1 Display the Option Setting Menu (page 141).

2 Select "TV OUTPUT", and press the SET button.

TV SYSTEM:

Set the type of TV signal that is output from the COMPONENT/AV terminal.

TV TYPE:

Set the TV's aspect ratio.

COMPONENT/HDMI:

Set the signal that is output from the COMPONENT/AV and/or HDMI terminal.

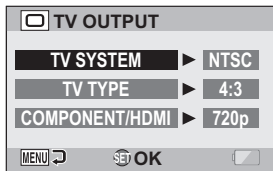



TV OUTPUT SETTING



- 3** Select the desired setting, and press the SET button.
- The screen to change the parameter for the selected setting appears.
- <If “TV SYSTEM” is selected>
- NTSC:** Outputs NTSC video signals.
PAL: Outputs PAL video signals.
- <If “TV TYPE” is selected>
- 4:3:** Use this setting when a TV having an aspect ratio of 4:3 is connected.
16:9: Use this setting when a TV having an aspect ratio of 16:9 is connected.
- <If “COMPONENT/HDMI” is selected>
- 1080i:** The output signal is set to 1080i.
720p: The output signal is set to 720p.
480p: The output signal is set to 480p.
-
- 4** Toggle the SET button up or down to select the desired parameter.
-
- 5** Press the SET button.
-
- 6** Press the MENU button.
- This completes the TV output setting.

■ Relation between “TV TYPE” setting and TV display

The tables below show the video signal that is output when the “TV TYPE” setting is changed. However, note that for some TVs that have an auto-detect function, the output may not conform to the table, or the TV display may not change at all.

“TVTYPE” setting	TV type to be connected	Image file to be displayed	TV display
4:3	4:3	Still image (4:3)	
		Video clip in SD mode	
		Video clip in HD mode	

TV OUTPUT SETTING

"TVTYPE" setting	TV type to be connected	Image file to be displayed	TV display
16:9	16:9	Still image (4:3)	
		Video clip in SD mode	
		Video clip in HD mode	

* The still image examples are for images captured in a 16:9 still image mode.

CAUTION

If the TV display is not correct...

- If the appearance of the image on the TV monitor is not correct, you can either change the camera's "TV TYPE" setting, or change the screen size setting on your TV. To change the screen size setting on your TV, please refer to the instruction manual for your TV.

The aspect ratio of the output still image does not change to 16:9?

- The still image output will be 4:3 for images captured in a 16:9 still image mode.

POWER SAVE FUNCTION

Your camera has a “power save” function whereby the power automatically turns off after a specified period of inactivity. The power save function works to conserve the battery pack power when the camera is not being used, or to prevent the battery pack from dying if the camera has accidentally been left on. You can specify the elapsed time (standby time) before the power save function is activated.

1 Display the Option Setting Menu (page 141).

2 Select “POWER SAVE”, and press the SET button.

BATT:REC:

Set the standby time for the shooting modes when the battery pack is used.



BATT:PLAY:

Set the standby time for the playback modes when the battery pack is used.

AC:REC/PLAY:

Set the standby time for the shooting and playback modes when using an AC power source.

BLUE LIGHT:

Turn the ring-type blue LED indicator encircling the []/[] buttons ON or OFF.

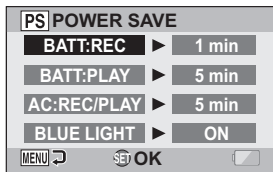

POWER SAVE FUNCTION

- 3** Select the desired option, and press the SET button.
- The Set Standby Time Screen appears.

- 4** Toggle the SET button up or down to set the standby time.
<If "BATT:REC", "BATT:PLAY" or "AC:REC/PLAY" was selected in step 3>

Up:

Increases the standby time.

Down:

Decreases the standby time.

<If "BLUE LIGHT" was selected in step 3>

ON:

The ring LED is lit.

OFF:

The ring LED is not lit.

-
- 5** Press the SET button.

-
- 6** Press the MENU button.
- The standby time is set.

FILE NO. MEMORY

If a newly formatted card is used, the file name (image number) of the captured image automatically begins from 0001. If the card is subsequently reformatted, or if a different reformatted card is used, the file names again begin from 0001. This is because the file number memory function is set to "OFF", and consequently it results in more than one card containing images with the same numbers. By setting the file number memory function to "ON", even if the card is reformatted or the card is replaced with another card, the consecutive numbering of file names continues from the last number recorded by the camera.

<File number memory function "OFF">

	File name (image number)
Card A	0001, 0002..... 0012, 0013

⋮
Replace card

↓

Card B	0001, 0002..... 0012, 0013
--------	----------------------------

<File number memory function "ON">

	File name (image number)
Card A	0001, 0002..... 0012, 0013

⋮
Replace card

↓

Card B	0014, 0015.....0025, 0026
--------	---------------------------

FILE NO. MEMORY

- If Card B already has files in it when it replaces Card A, file names are assigned as follows.

When the highest file number on Card B (before replacing) is lower than the highest file number on Card A: the file name of the next recorded image continues from last file name recorded on Card A.

Card A	0001, 0002 0012, 0013
--------	-----------------------------

↓
Replace card

Card B	0001, 0002, 0014, 0015 0025, 0026
--------	---

└──────────┘
Previously recorded files

When the highest file number on Card B (before replacing) is higher than the highest file number on Card A: the file name of the next recorded image continues from last file name recorded on Card B.

Card A	0001, 0002 0012, 0013
--------	-----------------------------

↓
Replace card

Card B	0020, 0021, 0022, 0023 0025, 0026
--------	---

└──────────┘
Previously recorded files

1 Display the Option Setting Menu (page 141).

2 Select “FILE NO. CONT’D”, and press the SET button.

ON:

The file number memory function is on.

OFF:

The file number memory function is off.

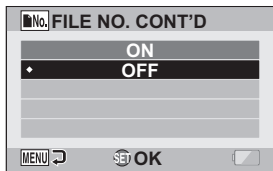

3 Select the desired setting, and press the SET button.

- The selected file number memory function is set.

HINT

- Until the file number memory function is turned “OFF”, consecutive file names are assigned. It is recommended that the file number memory function be returned to “OFF” at the end of each photography session.

FORMATTING A CARD

A card must be formatted with this camera:

- After purchasing, when used for the first time, or
- If it was formatted using a personal computer or another digital camera.

The card cannot be formatted if the lock switch is set to the "LOCK" position. Proceed with the format procedure after setting the lock switch to the unlocked position.

1 Display the Option Setting Menu (page 141).

2 Select "FORMAT", and press the SET button.

- In normal use, a full format is not necessary. However, in case a card error occurs even after normal formatting, executing a full format may resolve the problem.

FORMAT:

A normal formatting is executed.

FULL FORMAT:

The entire card is scanned and formatted. (When there is little battery power remaining, this setting cannot be selected.)

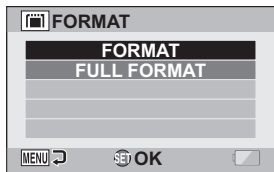

3 Select the desired format option, and press the SET button.

- A confirmation screen appears.

4 Select “YES”, and press the SET button.

- Formatting begins.
- During formatting, “Formatting” and “do not power off” are shown on the monitor.

CAUTION

Caution during formatting

- Do not turn off the power to the camera or eject the card during formatting.

Formatting erases the data

- When a card is formatted, all data recorded on the card is erased. Protected data (page 122) is also erased, so before formatting a card, any data you want to keep should be copied to your personal computer’s hard disk or other storage medium.

Caution regarding disposing/transferring the card (recovering data from a reformatted card)

- If a card is reformatted or the data is erased from the card using the camera or a computer, the card’s control data may be merely modified and the data itself may not be completely erased from the card.
- In some cases it may be possible to recover the data from a reformatted card using special software for that purpose. However, if the camera is used to execute a full format, it will be impossible to recover the data even by the use of data recovery software.
- If you are disposing of a card, it is recommended that you physically destroy it. If you are transferring the card to someone else to use, it is recommended that you use the camera’s full format function to reformat the card, or use commercially available software for erasing card data. Managing data is the responsibility of the user.

HINT

To cancel formatting

- In step 4, select “NO”, and press the SET button.

RESETTING THE CAMERA SETTINGS

Reset the camera to the factory-preset settings.

1 Display the Option Setting Menu (page 141).

2 Select “RESET SETTINGS”, and press the SET button.

RESET:

Reset to the factory-preset settings.

EXIT:

Do not change the settings, and return to the Option Setting Menu.

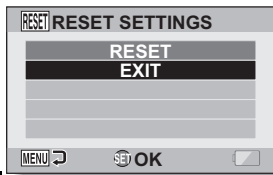

3 Select “RESET”, and press the SET button.

- The camera settings are reset to the factory-preset settings.
-

HINT

- Note that the following settings do not change with this procedure:
 - Date and time setting
 - Language setting
 - TV system setting

CHECKING THE REMAINING CARD MEMORY

You can check how many images can be captured and how much recording time is available on the card. For a table showing the maximum number of images and recording time for specific cards, please see "Possible No. of Images/Possible Shooting Time/Possible Recording Time" on page 216.

Checking the remaining number of images and video recording time

1 Set the REC/PLAY switch to REC, and turn on the camera.

- The remaining number of images appears in the upper left of the monitor.
- The remaining video recording time appears in the upper right of the monitor.
- The remaining number of images and video recording time will differ depending on the resolution and compression settings.

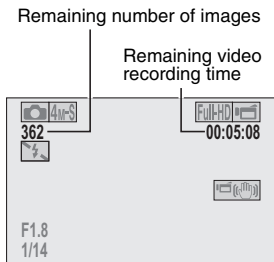

For audio recordings

1 Set the camera to the audio recording mode (page 96).

- The remaining audio recording time is shown.

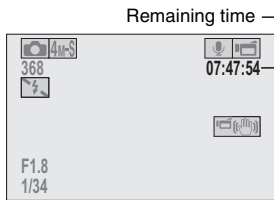

CHECKING THE REMAINING CARD MEMORY

HINT

- When the remaining number of images or the remaining video recording time is "0", you cannot capture any more images. To capture more images, either install a new card, or save the images to a computer and then delete them (page 88) from the card.
- When the remaining number of images or the remaining video recording time is "0", it may be possible to capture a few more images by setting a lower resolution setting (pages 71, 93 and 94), or selecting a different image quality setting.

CHECKING THE REMAINING BATTERY PACK CHARGE

When using the battery pack, the remaining battery pack charge can be checked on the monitor. Make sure to check this indicator before capturing an image. For an indication of the possible length of time for battery pack operation, see page 215.





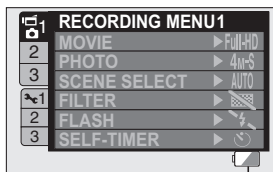

1 Display the Shooting Menu or Playback Menu (page 49).

- The battery pack remaining charge indicator appears in the lower right corner of the monitor.
- Due to the battery pack characteristics, when the ambient temperature is low,  may appear early for an incorrect indication of the remaining charge.

Also, depending on the conditions of use of the camera or the ambient conditions (temperature, etc.), the indicated remaining charge may change. Therefore, this indication can only be used as a general approximation of the remaining charge.



Battery pack remaining charge indicator

Battery pack remaining charge indicator	Battery remaining charge
No indication, or 	Approx. full.
	Power is low.
	It will soon be impossible to capture or play back images.
	If this icon flashes when the [] button or [] button is pressed, images cannot be captured. Recharge the battery pack.

CHECKING THE REMAINING BATTERY PACK CHARGE

HINT

- If any file is present, you can also check the remaining battery pack charge on the Information Screen (page 140).
- Battery life may differ even among battery packs of the same type.
- Depending on the usage of the camera (such as the number of times the flash is used, the use of the monitor, etc.) or the ambient temperature (temperatures below 10 °C [50°F]) the number of images that can be saved on a fully charged battery pack will vary greatly.
- It is recommended that you prepare an extra battery pack(s) when taking pictures at a wedding or while traveling, for example, so you don't miss capturing images of important moments due to the battery pack power running out. The same is recommended for taking photos in cold environments. (In a ski area, for example, the battery pack can be kept warm in your pocket until ready to use.)

CONNECTING TO A STANDARD VIDEO INPUT TERMINAL

About image output: The image output destination differs depending on the connection cable.

Connection cable	Image output destination	Recording mode		Playback mode
		Standby	Recording	
Dedicated S-AV interface cable	Camera monitor	NTSC: × PAL: ○	○	×
	TV	NTSC: ○ PAL: ×	×	○
Dedicated component cable	Camera monitor	×	○	×
	TV	○	×	○
HDMI cable	Camera monitor	×	○	×
	TV	○	×	○

○: Images are output ×: Images are not output

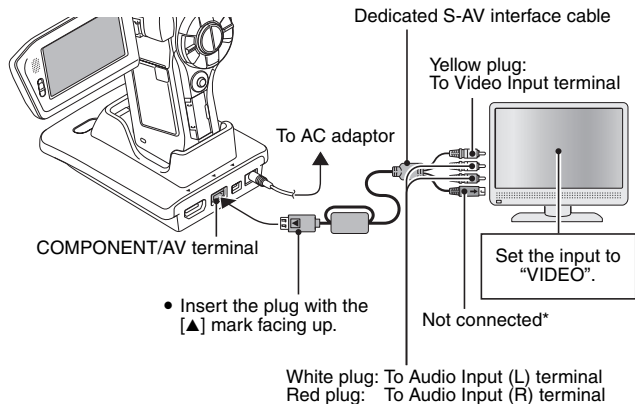

* When connected, the images are not produced normally on the TV monitor.

ENJOY HIGHER IMAGE QUALITY

Connect to the S-VIDEO terminal

<When connecting to an S-VIDEO input terminal>

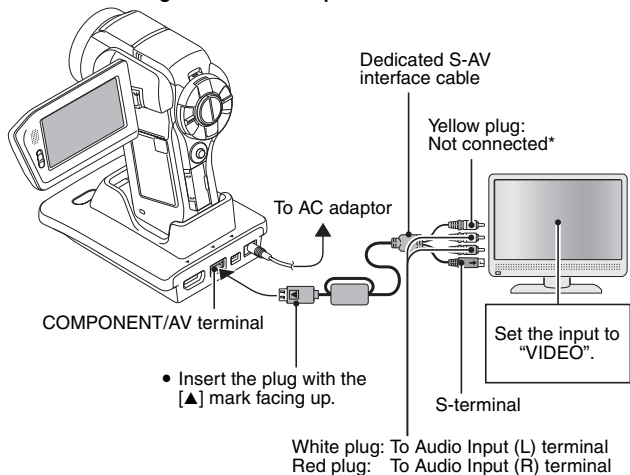

* When connected, the images are not produced normally on the TV monitor.

Connect to the 480p/720p/1080i terminal

If your TV has a 480p/720p/1080i input terminal, you can enjoy the high video quality of component output from your camera.

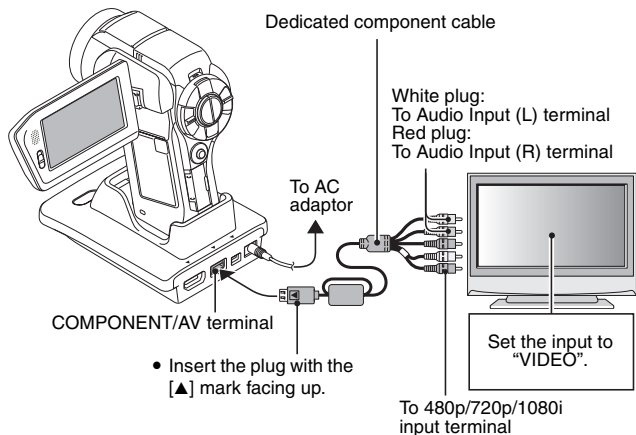

NOTE

If your TV does not have 480p/720p/1080i video input capability

- The images will not appear on the TV.

Camera Menu Screen and TV Menu Screen

- The Menu Screen appears only on the TV monitor, so please operate the camera while looking at the TV monitor.

Insert and pull out the cable carefully

- When connecting the cables, make sure that the cable plugs are correctly oriented and that they match the shapes of the terminal sockets on the devices. Push the plugs in straight when connecting them. If undue force is used to connect a cable, it may permanently damage the connector pins in the terminal socket.
- Do not use excessive force when connecting and disconnecting cables.

ENJOY HIGHER IMAGE QUALITY

Connecting to the HDMI terminal

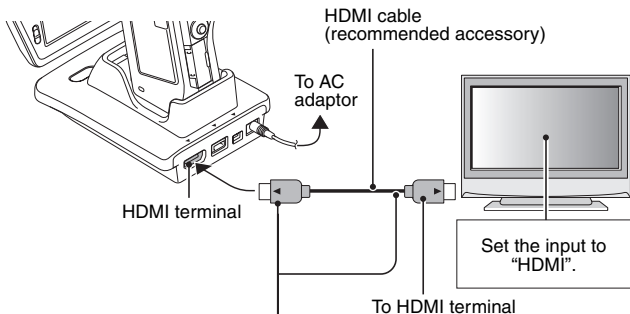

To reduce spurious radiation

- Please affix the cores (included)

<Docking station end>

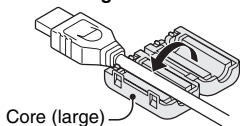

<TV end>

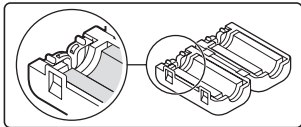
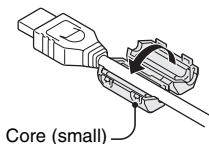

HINT

- HDMI, the HDMI logo and High-Definition Multimedia Interface are trademarks or registered trademarks of HDMI Licensing, LLC.

HDMI[™]
HIGH-DEFINITION MULTIMEDIA INTERFACE

PLAYING BACK ON A TV

- After connecting the camera to the television, switch the TV input to the terminal to which the camera is connected.
- When the camera is connected to a TV, no image appears on the camera's monitor.
- The playback method is the same as when viewing images on the camera's monitor.

Audio playback: see page 97

- The remote control unit can be used for playback (page 82).
- The same playback procedure as when playing back with the camera is used to play back audio recordings as well.
- If the camera set in the docking station is in the sleep mode, press the operation mode button on the docking station, or the ON/OFF button on the remote control unit, to turn the camera on.

CAUTION

Insert and pull out the cable carefully

- When connecting the cables, make sure that the cable plugs are correctly oriented and that they match the shapes of the terminal sockets on the devices. Push the plugs in straight when connecting them. If undue force is used to connect a cable, it may permanently damage the connector pins in the terminal socket.
- Do not use excessive force when connecting and disconnecting cables.

HINT

About the display when the "PAL" TV system is selected (page 156) and the supplied S-AV interface cable is used to connect the camera to the TV

During recording: The image appears on the monitor only; it does not appear on the TV.

During playback: The image appears on the TV only; it does not appear on the monitor.

Xacti Library

The Xacti Library feature allows you to save files recorded with your camera to a large-capacity hard disk without using a computer and play them back on your TV. No computer operation is involved. You can view full high-definition images right on your TV screen.

In addition, you have access to file operations such as copy and delete, as well as file management using the calendar.

For detailed information about using Xacti Library, please see the separate Xacti Library Instruction Manual.

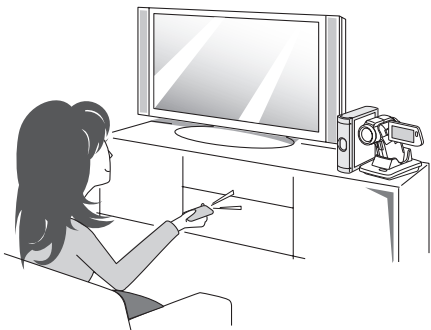

PictBridge MODE

Your camera supports the PictBridge function. By connecting the camera directly to a PictBridge-enabled printer, the camera's monitor can be used to select images and initiate printing (PictBridge printing).

- 1** Install the card in the camera, open the monitor unit to turn on the camera, and turn on the printer.
- 2** Use the supplied docking station to connect the camera to the printer.

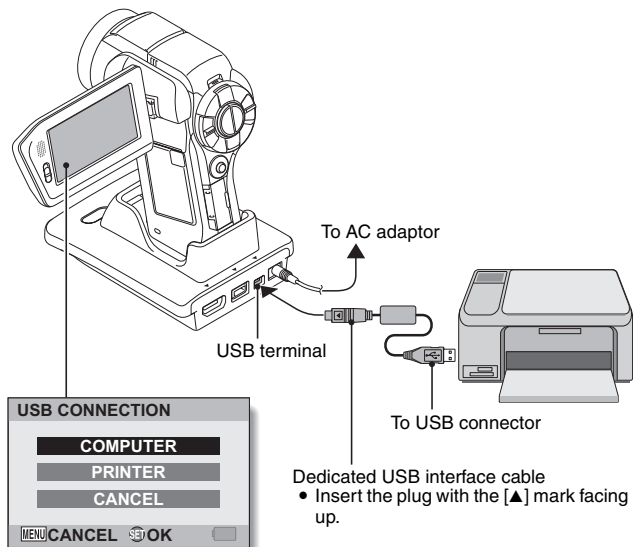

PictBridge MODE

3 Select “PRINTER”, and press the SET button.

4 The PictBridge printing mode is activated.

- The camera switches to the PictBridge printing mode, and the Printing Mode Screen appears.

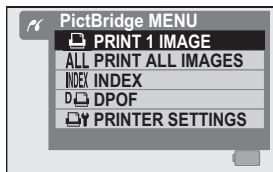

CAUTION

Insert and pull out the cable carefully

- When connecting the cables, make sure that the cable plugs are correctly oriented and that they match the shapes of the terminal sockets on the devices. Push the plugs in straight when connecting them. If undue force is used to connect a cable, it may permanently damage the connector pins in the terminal socket.
- Do not use excessive force when connecting and disconnecting cables.

Caution when connecting a printer

- If the power to the printer is turned off while it is connected, the camera may not operate correctly. If the camera does not operate correctly, disconnect the USB interface cable, turn off the camera, and then reconnect the cable.
- During PictBridge printing, the camera's button operation response is slower.
- If the camera is powered by the battery pack for printing, make sure that the remaining battery charge is sufficient.

PRINTING

Printing selected images

Procedure to select one still image and print it.

1 Complete the printing setup (page 178).

2 Select the one image icon , and press the SET button.

- The screen to select images for printing appears.

3 Toggle the SET button to the left or right to display the image you wish to print.

- Specify the image to print.

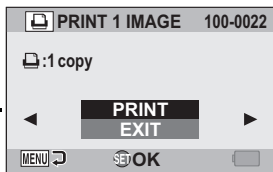

PRINTING

4 Specify the number of prints.

- ① Toggle the SET button up to select "COPIES", and press the SET button.
- ② Toggle the SET button up or down to specify the number of prints.
- ③ Press the SET button.
 - "PRINT" is selected.

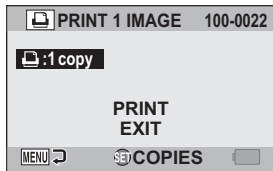

5 Press the SET button.

- Printing begins.

HINT

To cancel printing

- ① During printing, toggle the SET button down.
 - The Confirm Cancel Printing Screen appears.
- ② Select "CANCEL", and press the SET button.
 - If "EXIT" is selected and the SET button is pressed, printing resumes.

Printing all images

Print all of the images on the card.

1 Complete the print preparations (page 178).

2 Select the all images icon **ALL**, and press the **SET** button.

- The Print All Images Screen appears.

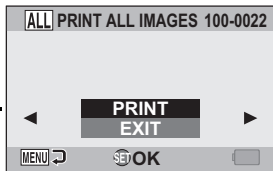

3 Select “PRINT”, and press the **SET** button.

- Printing begins.

CAUTION

Printing is not possible if there are more than 999 still images in the card

- Delete unwanted images before printing.

PRINTING

Making an index print

Make an index print of all the images on the card.

1 Complete the print preparations (page 178).

2 Select the index print icon **INDEX**, and press the **SET** button.

- The Index Print Screen appears.

3 Select “**PRINT**”, and press the **SET** button.

- Printing begins.

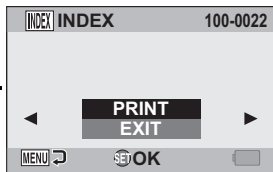

Printing images according to printing instructions (requested images)

Procedure to print all the ordered images.

- 1 Complete the print preparations (page 123), and complete the print preparations (page 178).**

- 2 Select the DPOF icon , and press the SET button.**

- The Print Requested Images Screen appears.

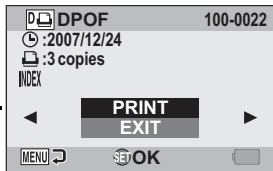

- 3 Select "PRINT", and press the SET button.**

- Printing begins.
- Printing begins about 1 minute after the SET button is pressed.

HINT

- In step 2, if you toggle the SET button to the left or right, you can view each image and confirm its printing instructions.

CAUTION

- Requested images printing  is not possible if a printer is used that does not support your camera's DPOF function.

PRINTING

Changing the printer settings

Images are printed according to settings specified by the camera, such as paper type, size, layout, printing quality, etc.

1 Complete the print preparations (page 178).

2 Select the printer settings icon , and press the **SET** button.

- The Printer Settings Screen appears.

MEDIA TYPE:

Specify the type of paper used for printing.

PAPER SIZE:

Specify the size of paper used for printing.

LAYOUT:

Specify how the images are to be arranged on the paper.

QUALITY:

Select the print quality for the images.

DATE STAMP:

Print the date the photo was taken.

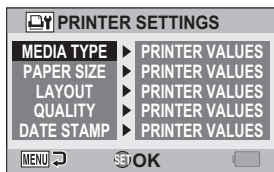

3 Adjust the printer settings.

- ① **Toggle the SET button up or down to select a printer setting parameter, and press the SET button.**
 - The screen to set the selected parameter appears.
- ② **Toggle the SET button up or down to adjust the setting, and press the SET button.**
 - The selected parameter is set, and you are returned to the Printer Settings Screen.
 - Follow the same procedure to adjust the other parameters, as desired.
 - The contents of the settings that can be made for each parameter will differ depending on the printer.

<When “PRINTER VALUES” is selected>

- The images will be printed according to the settings specified on the printer side.



<When “MEDIA TYPE” is selected>

4 Press the MENU button.

- You are returned to the Printing Mode Screen.

HINT

- The printer setting parameters will differ depending on the printer that is connected.
- To use printer functions which do not appear on your camera's Printer Settings Screen, select “PRINTER VALUES”.
- If a function set by the camera is not available in the printer, the camera's printer settings will automatically change to “PRINTER VALUES”.

CONNECTING A MICROPHONE/ HEADPHONES

A commercially sold stereo microphone as well as headphones can be connected to the camera.

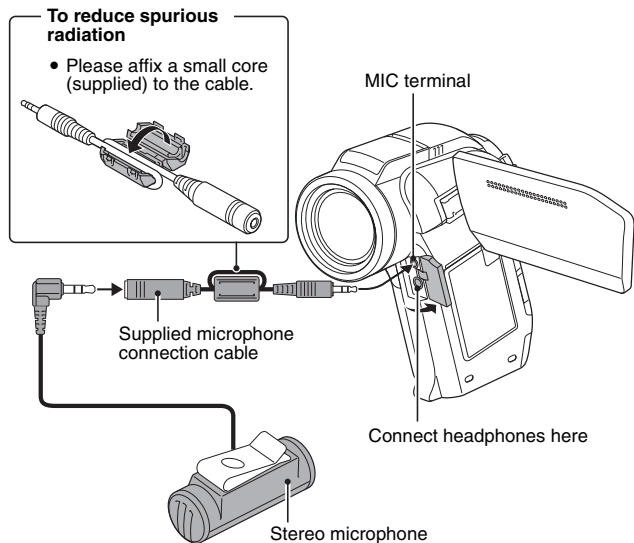

HINT

- The input level of the connected microphone can be adjusted (page 154).
- When an external microphone is connected, the camera's stereo microphone is disabled.
- When headphones are connected, the internal speaker output is turned OFF.
- It is recommended that you do not use headphones while driving an automobile or motorbike, while riding a bicycle or while walking.

SHOE MOUNT

Various devices—such as an external microphone, an auxiliary flash unit, a video light, etc.—can be attached to the shoe mount on top of the camera. Use the shoe mount for superior image quality when shooting.

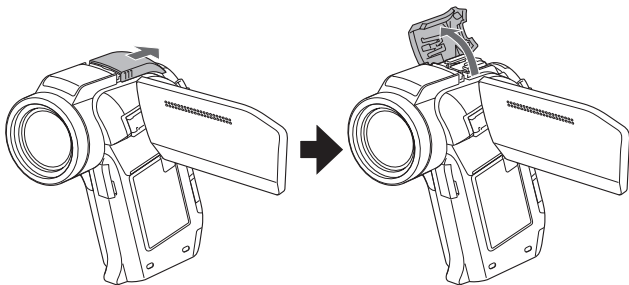

HINT

About connectable devices

- Only a slave flash unit can be used with the shoe mount.
- Note that the shoe mount on this camera is not a hot shoe.
- The shoe mount may not accommodate some devices, such as some large-size flash units or video lights.

CAUTION

- Take care not to apply undue force when attaching a device to the camera's shoe mount, as doing so may damage the shoe mount or the adaptor on the device.

COMMONLY ASKED QUESTIONS



If you have a question about the camera operation, you might find the answer in this compilation of commonly asked questions.

	Question	Answer	Action
Power	Why doesn't the power turn on?	Due to cold temperatures, the battery pack temporarily lost its power.	Place the camera in your pocket to warm it up before using it.
	Why is the battery pack consumed so quickly even after it was fully recharged?	The ambient temperature is very low.	Keep the battery pack in an environment of 10 to 40 °C (50 to 104°F).
	Why doesn't recharging end?	The battery pack life has expired.	Replace with a new battery pack. If this is not effective, consult your dealer.
	Why does the  icon appear?	The remaining battery pack power is low.	Use the supplied AC adaptor, or replace the battery pack with a fully charged one.
Shooting	Why does the multi-indicator flash red?	A recorded file is being saved on the card.	Not a malfunction. Wait until the multi-indicator turns off.
	Why doesn't the flash operate?	The camera has determined that the image is bright enough and the flash is not necessary.	Not a malfunction. Capture the image; the camera will determine when the flash is necessary.

	Question	Answer	Action
Shooting	Are the settings retained even after the camera is turned off?	—	All settings except the self-timer and the exposure compensation are retained even after the camera is turned off.
	Which resolution setting should I use?	—	Select the resolution setting according to the intended use: 8M , 4M-H , 4M-S : Appropriate for printing letter-size or larger, and for printing a close-up of part of a photo (trimming). 3.5M , 2M , 2M ,  : For printing standard photo (photo service) sizes. 0.9M , 0.3M : For photos displayed on a web page, or sent as e-mail attachments.

COMMONLY ASKED QUESTIONS

	Question	Answer	Action
Shooting	What is the difference between the digital zoom and the optical zoom?	—	Because shooting with the optical zoom uses the optics of a physical lens, you can shoot without losing minute details in the image. The digital zoom, on the other hand, works by magnifying a portion of the image that hits the image sensor and may produce a coarser image.
	How can I get the distant view into focus?	—	Set the scene select function to the landscape  mode when photographing. Or, set the focus range setting to manual focus MF , and set the distance to ∞.
	The video clip I shot outdoors is completely white.	—	Set the flicker-reduction setting to off.

	Question	Answer	Action
Monitor	When used in cold weather, why does the image seem to leave traces as it moves?	Condition due to the monitor characteristics.	Not a malfunction. Spots that appear in the monitor only appear in the monitor and will not be recorded with the images.
	Why does the displayed image contain some red, blue and green dots, or why are black spots visible?		
Viewing images	Why is the image too bright?	The subject was too bright.	When capturing an image, devise a way to compensate for a bright subject, for example, by changing the shooting angle.
	Why is the image out of focus?	The focus is not locked properly.	Hold the camera correctly and slowly press the [] button halfway to lock the focus. Then press the [] button all the way to capture the image.
	Why is a part of the image missing?	The image was captured at close range.	When capturing an image at close range, compose the image using the monitor.

COMMONLY ASKED QUESTIONS

	Question	Answer	Action
Viewing images	Why is there no image (□ is shown)?	This may happen when trying to play back images stored on a card from a different digital camera.	Play back images that were recorded on a card using this camera.
	Why isn't the magnified image clear?	Due to the characteristics of the camera, magnified images appear less clear.	Not a malfunction.
	Why isn't the captured image clear?	The image was captured using the digital zoom.	Not a malfunction.
	Can I play back image and sound files that I edited using my computer?	—	We cannot guarantee the accurate playback of files that have been edited using a computer.
	Why is there a motor-like sound during video clip playback?	The sound of the camera's mechanical action was recorded.	Not a malfunction.

	Question	Answer	Action
Connecting to a TV	Why is there no sound?	The volume on the TV is set to the minimum.	Adjust the volume on the TV.
	What is the difference among the normal video (composite video) output, S-video output and component/HDMI output?	—	Normal video (composite video) output: Combines Y (luminance) signal and chrominance signal and outputs the combined signal. S-video output: Outputs the Y signal and chrominance signal separately. Component/HDMI signal: Outputs the Y signal, B-Y signal and R-Y signal separately. The picture quality becomes increasingly higher, in order from normal video output, to S-video output, to component/HDMI output.
	Can the dedicated S-AV interface cable and the dedicated component cable be connected at the same time and output the image?	—	You cannot output the image when both cables are connected at the same time. Connect only one of the cables.

COMMONLY ASKED QUESTIONS



	Question	Answer	Action
Printing	Why does a message appear during PictBridge printing?	There is a problem with the printer.	Please refer to the instruction manual for your printer.
Misc.	The "Cannot edit video" message appears.	You have attempted to join video clips having different resolutions or frame rates.	Select video clips that have the same resolution or frame rate.
	Why is a noise heard from a nearby TV or radio during battery recharging?	Electromagnetic waves are emitted from the AC adaptor.	Move the AC adaptor further away from the TV or radio when recharging the battery pack.
	Why does the "Card full" message appear?	There is no more available memory on the card.	Delete unnecessary files, or use a card that has more memory available.
	Why does the "Card is protected" message appear?	The lock switch on the card is in the locked (protect) position.	Move the lock switch to the unlocked position.
	Why can't the camera be operated?	A temporary internal circuitry problem may be the cause.	Remove the AC adaptor and the battery pack from the camera, wait a few minutes, then reinstall the battery pack and try again.





	Question	Answer	Action
Misc	A problem such as inability to record or play back occurs.	The card contains files that were saved using a device other than this camera.	After saving your files to a different medium, format the card.
	Can I use my camera abroad?	—	When the camera is connected to a TV, you can switch the camera's video output to NTSC or PAL. If you have questions about using the AC adaptor and power cord abroad, please consult with a dealer near you for advice.
	Why does the "System error" message appear?	A problem has occurred within the camera or card.	Check the following items: ① Remove the card and then install it again. ② Remove the battery pack and then install it again. ③ Install a different card. If "System error" still appears after performing the above steps, then take the camera to the dealer for service.

TROUBLESHOOTING

Before taking your camera to the repair shop, check the following table for a possible solution to the problem.

Camera

	Problem	Cause	Action	Reference page
Power	No power.	The battery pack is dead.	Recharge the battery pack, or replace with a new battery pack. Or connect the AC adaptor (supplied).	33, 37
		The battery pack has not been inserted correctly.	Reinsert the battery pack, making sure to orient it correctly.	
	The camera turns off by itself.	The power save function is operating.	Turn on the camera again.	41
Shooting	An image is not captured when the  button or  button is pressed.	The power is not turned on.	If the power save function was activated, turn on the camera before shooting. If the camera was turned off, press the ON/OFF button to turn it on.	41



	Problem	Cause	Action	Reference page
Shooting	An image is not captured when the [] button or [] button is pressed.	The maximum number of images that can be captured or the maximum video clip recording time has been reached.	Install a new card.	27
			Delete the images that are not necessary.	88
	The flash does not operate.	The flash off mode is selected.	Set the flash to automatic flash mode or forced flash mode.	77, 102
		The flash unit is not open.	Press the  button to open the flash unit.	—
		The battery pack is dead.	Recharge the battery pack, or replace with a new battery pack. Or connect the AC adaptor (supplied).	33, 37
The digital zoom does not work.	The still image is set to  . The digital zoom setting is set to "OFF".	Set the still image to  or lower. Set the digital zoom setting to "ON".	94	

TROUBLESHOOTING

	Problem	Cause	Action	Reference page
Shooting	A warning tone (beep-beep-beep) sounds, and it is not possible to take a picture using the self-timer.	The battery pack is consumed.	Install a sufficiently recharged battery pack. Or connect the AC adaptor (supplied).	33, 37
	When zooming in or out, the zoom movement stops momentarily.	The optical zoom has moved to the maximum magnification position.	Not a malfunction. Release the zoom switch, and push it again.	81
	There is noise in the captured image.	The ISO sensitivity setting is too high.	Set the ISO sensitivity to a lower setting.	111
	The  icon appears, and shooting is not possible.	The camera's internal temperature is high.	Discontinue shooting, and wait for the camera to cool down before using it again.	—
Monitor	No playback image appears.	The REC/PLAY switch is not set to PLAY.	Set the REC/PLAY switch to PLAY.	46

	Problem	Cause	Action	Reference page
Viewing images	The image is too dark.	The flash was blocked by a finger or other object.	Hold the camera correctly, and make sure the flash is not obstructed.	68
		The subject was too far away.	Capture the image in the range of operation of the flash.	213
		The subject was lit from behind.	Use the forced flash mode.	77, 102
			Use the exposure compensation function.	119
			Use the spot light-measuring mode.	110
	There is not enough light.	Adjust the ISO sensitivity setting.	111	
	The video clip picture is flickering.	The video clip was filmed under fluorescent lighting.	Set the flicker-reduction setting to on.	152

TROUBLESHOOTING

	Problem	Cause	Action	Reference page	
Viewing images	The image is too bright.	The forced flash mode is selected.	Select a different flash mode.	77, 102	
		The subject was too bright.	Use the exposure compensation function.	119	
		The ISO sensitivity setting is incorrect.	Set the ISO sensitivity to AUTO .	111	
	The image is not in focus.	The subject is too close to the camera.	The focus setting is not correct.	Capture the image with the subject within the photographable range. Select the correct focus setting for your needs.	72, 109
		The camera moved when the [] button was pressed. (camera shake)			
		The focus is not locked properly.	Hold the camera correctly and slowly press the [] button halfway to lock the focus. Then press the [] button all the way to capture the image.	68, 75	
		The lens is dirty.			Clean the lens.

	Problem	Cause	Action	Reference page
Viewing images	The colors of the images captured indoors are not correct.	This is due to ambient lighting.	Capture the image using the forced flash mode.	77, 102
		The white balance setting is incorrect.	Set the white balance setting correctly.	113
	A part of the image is missing.	The strap or a finger was blocking the lens.	Hold the camera correctly, and make sure the lens is not obstructed.	68
	“No image” is shown.	There is no file in the installed card.	Play back after capturing images or making audio recordings.	—
	During audio playback, there is no sound.	The playback volume setting on the camera is too low.	Adjust the playback volume.	87

TROUBLESHOOTING

	Problem	Cause	Action	Reference page
Connecting to a TV	There is no color in the image. The image is distorted.	The TV output setting is not correct.	Select the correct TV output setting.	156
		Both the dedicated S-AV interface cable and the dedicated component cable are connected.	Make the correct connection.	173
	No image or sound.	The camera is not correctly connected to the TV.	Follow the instructions to make the connection correctly.	172 to 175
		The TV input is not set correctly.	Set the input on the TV to "VIDEO" or "HDMI".	
	The edge of the image is cut off.	This is a characteristic of the TV.	Not a malfunction.	—
Image editing	You cannot edit or rotate an image.	The protect mode is set.	Cancel the protect mode.	122

	Problem	Cause	Action	Reference page
Charging	The camera is set in the docking station but the installed battery is not being recharged.	The AC adaptor is not connected to the docking station.	Check that the power cord of the AC adaptor is connected correctly.	29
		The camera is not correctly connected to the docking station.	When inserting the camera in the docking station, push down on it to make sure that the connection between the camera and the docking station is secure.	29, 35
		The camera is turned on.	Turn the camera off. Alternatively, press the docking station's operation mode button [] to light the multi-indicator red.	218
Misc.	The "No card" message appears.	No card is inserted.	Turn off the power and insert a card.	27
	The "Image is protected" message appears and the file cannot be deleted.	You have attempted to delete a file that is protected from accidental erasure.	Set the protect setting for the file to UNLOCK.	122

TROUBLESHOOTING

	Problem	Cause	Action	Reference page
Misc.	The audio guide does not sound.	The audio guide setting is set to "OFF".	Set the audio guide setting to "ON".	144
	The recording capacity is less than that indicated in the section "Possible No. of Images/Possible Shooting Time/Possible Recording Time" (page 216).	The recording capacity is less than the value specified for the card.	Depending on the card, the capacity may be less than the specified value. Please refer to the instructions that accompanied the card.	—
	The battery pack appears to be swollen.	Normal change occurring with battery use. Even with normal correct use of the lithium-ion battery, it has a tendency to swell as the number of charge and discharge cycles adds up and it gradually approaches the end of its service life.	Not a safety hazard. If the battery quickly becomes depleted, for example, it has reached the end of its service life. Replace it with a new battery pack.	—

Docking station













	Problem	Cause	Action	Reference page
Remote control unit	The remote control unit does not seem to work.	The remote control unit is aimed at the TV (not at the camera's remote control sensor).	Aim the remote control unit at the camera's remote control sensor (within a range of about 15 degrees left or right horizontally from the remote control sensor).	30, 31
		Something is obstructing the space between the remote control unit and the camera's remote control sensor.	Remove or move the obstructing object.	
		The remote control unit battery is consumed.	Replace with a new battery.	
		The remote control unit battery is not correctly inserted.	Take care that the (+) and (-) poles are correctly oriented.	

TROUBLESHOOTING

	Problem	Cause	Action	Reference page
Remote control unit	The remote control unit does not seem to work.	The remote control unit is too far from the camera's remote control sensor.	Operate the remote control unit from a position up to 7 meters from the docking station.	30, 31
		The remote control codes for the remote control unit and camera's remote control sensor are different.	Change the remote control code.	32

Notes regarding the Scene Select feature and filters







Scene Select

Setting	Remarks
Sports 	Focus range:  cannot be selected.
Portrait 	
Landscape 	
Night view portrait 	
Snow & beach 	
Fireworks 	Focus range: Fixed at  Flash: Fixed at  .
Lamp* 	Focus range:  cannot be selected. Flash: Fixed at  Still image NR: Fixed at "OFF".







* When recording a video clip in dark surroundings, the shutter speed decreases to 1/15 sec in order to produce a sufficiently bright image. However, when the flicker-reduction function is set to "ON", the shutter speed during video clip recording becomes 1/100 sec or 1/120 sec.

TROUBLESHOOTING

Filter

Setting	Remarks
Cosmetic 	Focus range:  cannot be selected.
Monochrome 	Still image mode:  cannot be selected.
Sepia 	Focus range:  cannot be selected.

About the scene select function and focus range settings

- The scene select function changes to  when the focus range is set to .
- Even if you set the focus range to ,  or , it changes to  when the scene select function is set to any setting other than .

SPECIFICATIONS





Camera

Type	Digital Movie Camera (recording and playback)
Recorded image file format	Still images: JPEG format (DCF, DPOF, Exif 2.2 compliant) Note: Designed mainly by the Japan Electronics and Information Technology Industries Association (JEITA), DCF (Design rule for Camera File system) is standard for digital still camera image files to provide interoperability between digital photography devices for the images stored on removable memory cards. However, it is not guaranteed that all devices will support the DCF standard. Video clips: Conforms to ISO-standard MPEG-4 AVC/H.264* Audio: MPEG-4 audio (AAC compression) 48 kHz sampling rate, 16-bit stereo format
Data storage media	SD Memory Card (equivalent to a maximum 8 GB SDHC Memory Card)
Image sensor/camera effective number of pixels	CMOS sensor Still images: Approx. 4 million pixels Movies (HD mode): Approx. 3.56 million pixels Movies (SD mode): Approx. 2.18 million pixels

* Video clip files recorded with models VPC-CA65 and VPC-CG65 are in the same H.264 format as this model. However, such files cannot be played back, since they are not compatible due to differences such as the data compression method.

SPECIFICATIONS

<p>Still image shooting mode (recording resolution)</p>	<p>8M: 3264 × 2448 pixels (approx. 8 million pixels) 4M-H: 2288 × 1712 pixels (approx. 4 million pixels, low compression) 4M-S: 2288 × 1712 pixels (approx. 4 million pixels, normal compression) 3.5M: 2496 × 1408 pixels (approx. 3.5 million pixels, 16:9 aspect ratio) 2M: 1920 × 1080 pixels (approx. 2 million pixels, 16:9 aspect ratio) 2M: 1600 × 1200 pixels (approx. 2 million pixels) 0.9M: 1280 × 720 pixels (approx. 900,000 pixels, 16:9 aspect ratio) 0.3M: 640 × 480 pixels (approx. 300,000 pixels) : 2288 × 1712 pixels (approx. 4 million pixels, sequential shots)</p>	
<p>Video clip recording mode (recording resolution)</p>	<p>HD mode Full-HD: 1920 × 1080 pixels, 60 field/s HD-HR: 1280 × 720 pixels, 60 fps HD-SHQ: 1280 × 720 pixels, 30 fps SD mode TV-HR: 640 × 480 pixels, 60 fps TV-SHQ: 640 × 480 pixels, 30 fps 16:9SHQ: 320 × 240 pixels, 30 fps * The 60 fps frame rate of this camera is 59.94 fps, and the 30 fps frame rate is 29.97 fps.</p>	
<p>White balance</p>	<p>Full-auto TTL, manual setting possible</p>	
<p>Lens</p>	<p>Optical 10× zoom lens</p>	<p>Still image shooting: f = 6.3 mm to 63.0 mm (35 mm film camera conversion 38 mm to 380 mm) Video clip recording: f = 6.3 mm to 63.0 mm (35 mm film camera conversion 49.7 mm to 497 mm) Autofocus, 8 groups, 11 elements (including three with five aspheric surfaces) Galvanometer iris Internal ND filter</p>
<p>Aperture</p>	<p>Open F = 1.8 (Wide) to 2.5 (Tele) Smallest F = 8.0 (Wide) to 11 (Tele)</p>	

Exposure control type	Programmable AE/Shutter speed priority AE/ Aperture priority AE/Manual exposure control Exposure compensation available from the Shooting Setting Screen (0 ±1.8 EV in 0.3 EV steps)
Light-measuring mode	Multi-section measuring, center-weighted measuring, spot measuring
Range	Total mode: 10 cm (3.94 in.) to infinity (Wide end) 1 m (3.28 ft.) to infinity (Tele end) Normal mode: 80 cm (31.50 in.) to infinity Super macro mode: 1 cm (0.39 in.) to 1 m (3.28 ft.) (Wide end only)
Digital zoom	For shooting: 1× to approx. 10× For playback: 1× to 58× (varies with resolution)
Shutter speed	Still image shooting mode: 1/2 to 1/1,000 sec. (Maximum approx. 4 seconds when scene select function set to lamp ) (During flash: 1/30 to 1/1,000 sec.) Sequential shots mode: 1/15 to 1/1,000 sec. (no flash) Video clip recording mode: 1/30 to 1/10,000 sec. (1/15 sec. max.: when scene select function is set to lamp mode )
Sensitivity	Still image shooting (standard output sensitivity*)/ video clip recording mode: Auto (video clip recording: ISO 50 to 800; still image shooting: ISO 50 to 200)/ISO 50, ISO 100, ISO 200, ISO 400, ISO 800, ISO 1600, and ISO 3200 (switchable from Shooting Setting Screen) * Sensitivity measured in compliance with the ISO standard (ISO 12232:2006). * Maximum ISO sensitivity up to 1600 equivalent when Scene Select function is set to  . * Recorded at ISO 1600 in the video clip recording mode, even if ISO sensitivity setting is  .

SPECIFICATIONS

Minimum subject illumination	9 lux (1/30 sec in the scene select AUTO mode) 3 lux (1/15 sec in the HIGH SENSITIVITY or lamp mode)	
Image stabilizer	Movie: Electronic Still image: Multi-calculation electronic	
Monitor	2.7" (6.9 cm) low-temperature polysilicon TFT color wide liquid crystal (transmissive), approx. 230,000 pixels	
Flash working range	GN = 6.2 Approx. 20 cm (7.87 in.) to 6.0 m (19.69 ft.) (Wide) Approx. 1.0 m (3.28 ft.) to 5.0 m (16.40 ft.) (Tele)	
Flash modes	Auto-flash, forced flash, flash off, red-eye reduction	
Focus	TTL-type AF (still image shooting mode: 9-point range finder/spot focus; video clip recording mode: Continuous focus), manual focus (22 steps)	
Self-timer	Approx. 2-second delay, 10-second delay	
Ambient environment	Temperature	0 to 40 °C (32 to 104°F) (operation), -20 to 60 °C (-4 to 140°F) (storage)
	Humidity	30 to 90% (operating, no condensation) 10 to 90% (storage, no condensation)
Power supply	Battery pack (supplied)	Li-ion battery pack (DB-L50) ×1
	AC adaptor (supplied)	VAR-G8
Power consumption	4.2 W (When using the Li-ion battery during recording)	
Dimensions (excluding protrusions)	90 (W) × 112.6 (H) × 54.5 (D) mm 3.54 (W) × 4.43 (H) × 2.15 (D) in. (Maximum dimensions) Volumetric capacity: Approx. 272 cc	
Weight	Approx. 268 g (9.5 oz.) (camera only [without battery pack and card])	

Camera connectors

[COMPONENT/AV] (480p/1080i/720p output) terminal*	Regrouped jack	
	Audio output	265 mVrms (−9 dBs), 12 kΩ or less, stereo
	Video output	1.0 Vp-p, 75 Ω unbalanced, sync negative, composite video NTSC color TV system/PAL color TV system (switchable from the Option Screen)
	S-video output	Y signal: 1.0 Vp-p, 75 Ω, unbalanced, sync negative C signal: 0.286 Vp-p, 75 Ω, unbalanced NTSC color TV system/PAL color TV system (switchable from the Option Screen)
	For 480p/1080i/720p video output Y signal: 1.0 Vp-p/75 Ω unbalanced, tri-level sync Pb and Pr signals: 0.7 Vp-p/75 Ω unbalanced	
[HDMI] terminal*	Video output Total number of scan lines (effective number of scan lines): 750p (720p)/1125i (1080i)/525p (480p) Audio output: L-PCM 48 kHz sampling	
[USB] terminal*	USB 2.0 High-speed	
[MIC] (microphone input) terminal	ø2.5 mm stereo mini jack (converts to a ø3.5 mm stereo mini jack by the supplied microphone connection cable), 2 kΩ Sensitivity: less than −42 dB (plug-in power type microphone)	
Headphone jack	ø3.5 mm mini-jack (stereo headphone jack, impedance 16 Ω to 32 Ω)	
	Audio output	310 mVrms (−8 dBs), 47 kΩ, stereo
DC IN (external DC power input) terminal	DC 5 V (for exclusive use with the supplied AC adaptor [VAR-G8])	

* via the docking station

SPECIFICATIONS















Battery life

Shooting	Still image shooting mode	Approx. 340 images: CIPA standard (when a Hagiwara Sys-Com 512 MB SD Memory Card is used)
	Video clip recording mode	Approx. 120 minutes: Recorded in FullHD mode
Playback		Approx. 275 minutes: Monitor on, continuous playback

- Until battery pack runs out when using a fully charged battery pack at a 25 °C (77°F) ambient temperature.
- The operation time may vary depending on the conditions of the battery pack and the conditions of use. Especially when used at temperatures below 10 °C (50°F), the battery pack operation time is significantly reduced.

Possible No. of Images/Possible Shooting Time/ Possible Recording Time

The table shows the possible number of captured images and the possible recording times for commercially available SD Memory Cards (2 GB, 4 GB, 8 GB).

Shooting/ recording mode	Resolution setting	SD Memory Card		
		2 GB	4 GB	8 GB
Still image mode		756 images	1,510 images	3,030 images
		1,010 images	2,030 images	4,080 images
		1,510 images	3,020 images	6,070 images
		1,670 images	3,350 images	6,730 images
		2,810 images	5,640 images	11,310 images
		2,950 images	5,900 images	11,850 images
		6,200 images	12,410 images	24,900 images
		15,500 images	31,020 images	62,250 images
Video clip mode	 	21 min. 21 sec.	42 min. 44 sec.	1 hr. 25 min.
		28 min. 11 sec.	56 min. 25 sec.	1 hr. 53 min.
		41 min. 26 sec.	1 hr. 22 min.	2 hr. 46 min.
		1 hr. 18 min.	2 hr. 36 min.	5 hr. 14 min.
		4 hr. 19 min.	8 hr. 38 min.	17 hr. 21 min.
Audio recording mode	—	32 hr. 25 min.	64 hr. 53 min.	130 hr. 12 min.

- The maximum video clip continuous recording time is approx. 5 hours 30 minutes at the  setting.
- Up to 13 hours of continuous audio recording is possible.
- When recording a video clip using an 8 GB card, recording terminates when the size of the file currently being recorded reaches approx. 4 GB.
- The above values apply when an SD Memory Card by Sandisk is used.
- Even with cards of the same capacity, the amount of data that can actually be stored may differ depending on the card brand, etc.
- The continuous shooting time for each video clip will differ depending, for example, on the card capacity, environmental conditions (temperature and shooting conditions, etc.).

SPECIFICATIONS

Docking station

Part number	PDS-HD1000	
Power supply	DC 5V	
Rated output	DC 5V	
Ambient environment	Temperature	0 to 40 °C (32 to 104°F) (recharge), -20 to 60 °C (-4 to 140°F) (storage)
	Humidity	20 to 80% (no condensation)
Dimensions	105.5 (W) × 44.4 (H) × 80.5 (D) mm 4.15 (W) × 1.75 (H) × 3.17 (D) in.	
Weight	Approx. 86 g (3.0 oz.)	

Remote control unit

Part number	BRC-C3	
Power supply	Lithium battery (CR2025)	
Dimensions	35 (W) × 56.6 (H) × 6.5 (D) mm 1.38 (W) × 2.23 (H) × 0.26 (D) in.	
Weight	Approx. 11 g (0.4 oz.) (including battery)	

Concerning the multi-indicator and blue LED indicator

Multi-indicator

The camera's multi-indicator will light, flash, or be off, depending on the different camera operations.

Color	Multi-indicator status	Camera status	
Green	Lit	Connected to a computer or printer	
	Flashing	Power save mode active	
Orange	Lit	Connected to a TV	
Red	Lit	Charging	
	Flashing	Slow	During self-timer photography
		Fast	Accessing card
		Very fast	Battery charge error or rise in internal temperature

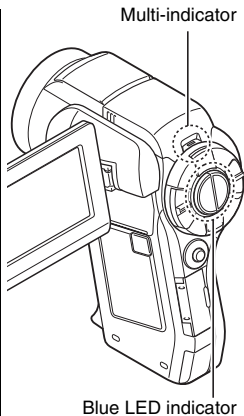

Blue LED indicator

The blue LED indicator lights during certain operations, such as when the camera is turned ON or OFF, when saving video clip or still image data, during video clip playback, etc.

SPECIFICATIONS

Supplied AC adaptor

Part number	VAR-G8	
Power source	AC 100 V to 240 V, 50/60 Hz	
Rated output	DC 5 V, 2.0 A	
Ambient environment	Temperature	0 to 40 °C (32 to 104°F) (operation), -20 to 60 °C (-4 to 140°F) (storage)
	Humidity	20 to 80% (no condensation)
Dimensions	49.5 (W) × 25.5 (H) × 68.3 (D) mm 1.95 (W) × 1.00 (H) × 2.69 (D) in.	
Weight (without power cord)	Approx. 169 g (6.0 oz.)	
Power cord rated value	VPC-HD1000	AC 125 V, 7 A
	VPC-HD1000EX	AC 250 V, 2.5 A
	VPC-HD1000GX	Differs depending on the country

- When using the supplied AC adaptor abroad, the power cord may need to be replaced in accordance with local requirements. Please contact your local dealer for details.

Supplied Li-ion battery pack

Model number	DB-L50	
Voltage	3.7 V	
Capacity	1,900 mAh	
Ambient environment	Temperature	0 to 40 °C (32 to 104°F) (during use, when charging) -10 to 30 °C (14 to 86°F) (storage)
	Humidity	10 to 90% (no condensation)
Dimensions	53.1 (W) × 11.4 (H) × 35.3 (D) mm 2.09 (W) × 0.45 (H) × 1.39 (D) in.	
Weight	Approx. 41 g (1.4 oz.)	

Others

Mac OS, QuickTime, iPod and iTunes are trademarks of Apple Inc., registered in the U.S. and other countries.

Microsoft and Windows are registered trademarks of Microsoft Corporation in the USA and other countries.

Intel and Pentium are registered trademarks of Intel Corporation (USA).

In this manual, the Microsoft® Windows® 2000 operating system, Microsoft® Windows® XP operating system, and Microsoft® Windows® Vista operating system are collectively referred to as “Windows”.

SDHC is a trademark.



HDMI, the HDMI logo and High-Definition Multimedia Interface are trademarks or registered trademarks of HDMI Licensing, LLC.



All other company and product names are registered trademarks or trademarks of their respective owners.

CAUTION

- It is forbidden to copy this manual, whole or in part, without prior written permission.
- All images and illustrations given in this manual are for explanation purposes and may differ slightly from that of the actual product. Also, actual specifications are subject to change without prior notice and therefore may differ from the contents of this manual.

SPECIFICATIONS

Before capturing those important shots, be sure to first take a test shot to confirm that your camera is set up and ready to go

- Sanyo Electric shall not be held responsible for any problems resulting from the use of this camera.
- Sanyo Electric declines all responsibility for damages due to improper use of the camera, failure to adhere to the instructions given in this manual, or repairs or changes done by those other than a technician authorized by the manufacturer.
- Sanyo Electric shall not be held responsible for any damage caused by optional devices or consumable items used with the camera other than those supplied with the camera or those specified by Sanyo Electric.
- As a precaution against losing data in case of a problem with your hard disk that prevents you from accessing your saved files, it's a good practice to regularly make backup copies, on a DVD for example, of the files in the hard disk you are using for the Xacti Library. Sanyo Electric shall not be held responsible for loss of files/data due to failure of your hard disk.
- Sanyo Electric shall not be held responsible for any losses or loss of revenue resulting from the loss of data caused by the malfunction, or the repairing of a malfunction, of the camera.
- The images captured with this camera will differ in quality from pictures taken with a standard film camera.



HINTS FOR TAKING PICTURES

Taking great pictures in difficult surroundings is easier than you might think. By keeping a few points in mind and choosing the correct settings, you can create photos that you'll be proud to display and share.

If images are blurred even when the autofocus is used

Your camera employs an autofocus function. When you snap a picture using the autofocus, the camera automatically adjusts the settings so that the image will be in focus. If you are getting blurred images even when using the autofocus, one or more of the following might be the reason.



■ How the autofocus works

The autofocus is activated when the [] button is gently pressed halfway. Press the [] button slightly, and the target mark will appear on the monitor to indicate that the autofocus has been activated. Next, continue to gently press the [] button all the way to snap the picture. This two-step method is the way to ensure that your photos are perfectly focused.

■ Reasons for unfocused images

- ① The [] button was pressed all the way in one step.
- ② After the image was focused, the subject moved.
 - Even if camera focuses the subject once, if the distance between the camera and the subject is changed, the subject may become out of focus.
- ③ The focus setting is not set for the correct distance.
 - If you shoot a close-up subject with the camera set to the normal focus mode, or if you shoot a subject at normal distance with the camera set to the super macro (close-up) mode (pages 72 and 107), the image will not be in focus.

■ Preventing blurred images

- ① Confirm that the camera is set to the correct focus mode for your subject.
- ② Hold the camera correctly, and press the [] button halfway.
- ③ Wait for the target mark to appear in the monitor, and holding the camera steady, gently continue to press the [] button all the way down.



Following these steps for a gentle but firm pressing of the [] button will ensure that you get beautifully focused photos.

HINTS FOR TAKING PICTURES

Photographing a moving subject

Situation: You would like to snap an action shot of a moving child or pet. The autofocus is activated, but because the subject is moving, the image may be blurred. In particular, when the distance between the camera and the subject is changing, it is difficult to lock the focus on the subject. Here are some hints for successfully capturing images of moving subjects.

■ Reasons for unfocused images

When the [] button is gently pressed halfway, the camera's autofocus works by determining the distance between the camera and the subject. Once the subject is in focus, if it then moves before the picture is snapped, the image may be out of focus. This often happens when you once lock the focus on a subject and then wait for the right moment to snap the picture. And, conversely, a blurred image may result if you press the [] button all the way in one step in an attempt to quickly capture an action scene, thus failing to activate the autofocus in time.

■ Preventing blurred images (How to use the manual focus [page 108])

In addition to the autofocus, a manual focus mode is also incorporated in your camera. In the autofocus mode, the distance between the camera and the subject is automatically determined when you press the [] button halfway. In contrast to this, with the manual focus mode, you manually set the focus by specifying the correct distance between the camera and the subject before taking the picture.

■ How to photograph a moving subject

- ① Set the camera's focus mode to the manual focus. Set the focus distance to the correct distance between the camera and the subject.
- ② When the subject is at the set focus distance, gently press the [] button all the way down.

<Advantage of using the manual focus>

- Images can be quickly captured without waiting for the autofocus to activate.
- Because you are presetting the focus distance, the focus can be more accurate.

<Using the manual focus effectively>

- When photographing a moving subject, press the [] button just before the subject reaches the focus distance, and the shutter will be released when the subject is at the correct distance.
- Use manual focus to avoid incorrectly focused images when there is an object between the camera and the subject you wish to focus on.

Shooting portraits (portrait mode)

Points:

- Choose a background that doesn't detract from your subject.
- Move in close to your subject.
- Pay attention to lighting and how it affects your subject.

NOTE

- If the background is distracting, it will not show your subject to his best advantage. Move in closer to your subject or zoom in so that the background does not compete with the subject.
- In portrait photography your subject is clearly the central figure, so try techniques that allow the subject to stand out.
- If light is coming from behind your subject (backlit), his face will appear dark. You can get a better picture by using the flash, for example, or changing the exposure compensation setting.

Photographing moving subjects (sports mode)

Points:

- Match the camera's movement with that of the subject.
- Set the zoom to the Wide end (wide-angle).
- Don't be too hesitant to press the [] button, or you'll miss the action.

NOTE

- Tips to not missing those great action shots: Make sure you're holding the camera correctly. Keep the subject in the lens at all times, moving the camera with him while waiting for the right shot. Move your whole body—not just your arms—with the camera while shooting.
- Blurred images are more likely when the zoom is set to the Tele end than the Wide end. Set the zoom as close as possible to the Wide end.
- Learn to press the [] button quickly yet smoothly the instant your photo chance occurs.

HINTS FOR TAKING PICTURES

Night photography (night view portrait mode)

Points:

- Avoid camera shake.
- Increase the ISO sensitivity.

NOTE

- Camera shutter speed during night photography is considerably slower, so there is a much greater chance that your photographed images will be blurry. Stabilize the camera when shooting.
- You can photograph your subject with the night scene in the background by using the flash. Be careful not to shoot too close to the subject, however, or your subject's face will appear too bright.
- After the flash operates, keep the camera and the subjects motionless for about 2 seconds.

Photographing scenery (landscape mode)

Points:

- Shoot using a high resolution.
- For zoom photography, use the optical zoom.
- Pay attention to picture composition.

NOTE

- When shooting with a wide-angle setting, or if you intend to enlarge the photo, the higher the resolution, the better.
- To zoom in on distant scenery, it's better to use the optical zoom. Using the digital zoom produces a coarser image. Hold the camera securely, keeping your elbows close to your body and making sure the camera is stable. Taking care to stabilize the camera will increase the likelihood of getting a clear photo.
- Don't forget to pay attention to picture composition; note perspective and be aware of how the placement of objects affects the scene.

SANYO

SANYO Electric Co., Ltd.